

Aeroquip®
1,500 psi PTFE Hose and Assemblies



Powering Business Worldwide

Table of Contents

General Characteristics.....	3
Compression Crimp Fittings	4
Flared Fittings	5
Protective Sleeves	6
Swivel Flared to Swivel Flared.....	7
Globeseal Flareless Fittings	8-9
Swivel Flareless to Swivel Flareless	10
How to Complete Hose Assembly Part Number.....	11
“super gem” Reusable Fittings	12-15
“super gem” Swivel Nut Globeseal Flareless & 4-Hole Flanged Elbows.....	16-18
“super gem” Swivel Flared to Swivel Flared.....	19
“super gem” Swivel Flareless to Swivel Flareless	20
“super gem” Swivel Flared to 4-Hole Flange	21
4-Hole Flange to 4-Hole Flange	22
Assembly of Medium Pressure PTFE Hose and “super gem” Reusable Fittings	23-24

Aeroquip PTFE Hose Assembly

Hose Assembly with Integral Polyester Chafe Guard – Hydraulic Service	25
Hose Assembly with Integral Polyester Chafe Guard – Fittings/Hose Assemblies.....	26
Hose Assembly with Integral Polyester Chafe Guard – Abrasion Comparison/Weight Compatibility.....	27
Hose Assembly with Integral Polyester Chafe Guard – How to Order	28
Aeroquip PTFE Hose Assemblies with Integral Silicone Firesleeve – Hydraulic Service	29
Aeroquip PTFE Hose Assemblies with Integral Silicone Firesleeve – Fittings/Hose Assemblies	30
Aeroquip PTFE Hose Assemblies with Integral Silicone Firesleeve – How To Order.....	31

Chemical Resistance

Eaton's Aeroquip 666/667 medium pressure PTFE hose is used in hydraulic and pneumatic applications at pressures up to 1500 psi (10,342.5 kPa). The hose is unaffected by all fuels, oils, alcohols, coolants, or solvents commonly used in aircraft. In addition, it is inert to acids both concentrated and diluted. Eaton's non-conductive version (AE116) is suitable for oxidizers and propellents used in the missile field.

The PTFE liner has sufficient conductivity to prevent electrostatically induced hose failures. The tube is capable of conducting a direct current equal to or greater than 6 micro-amps in sizes -4, -5, -6 and -8, and 10 micro-amps in size -10 and above with a potential of 1000 volts.

The method of construction of Eaton's Aeroquip PTFE hoses results in a lower volumetric expansion than any elastomer hose. This assures maximum response efficiency in ballistics ejection systems, and brake systems, where there can be no softness under shock load.

Inherent resiliency and toughness are ensured in the extruded tube by close control of factors affecting crystallinity. Additional structural strength is supplied in Eaton's Aeroquip PTFE hose by the tightly braided stainless steel wire reinforcement. The result is a lightweight hose able to withstand prolonged flexing and vibration under all service

conditions. The extruded tube has a tough, smooth, wax-like texture, which resists erosion. No materials of a sticky or viscous nature will stick to its surface.

PTFE hose has essentially zero moisture absorption. This together with its chemical inertness and anti-adhesive characteristics make it ideal for missile fluid systems where non-contamination and cleanliness are so essential, and for pneumatic systems when maintenance of low dew point is necessary.

Service and shelf life of Eaton's Aeroquip PTFE hose are unlimited for all practical purposes. However, experience has shown that service life on impulsing applications may eventually be limited by fatigue in the wire reinforcement. Maximum service life on such applications is best determined by the operator based on experience. See Eaton product brochure DS100-2.

Application Data

Eaton's Aeroquip 666/667 medium pressure PTFE hose may be used for all hydrocarbon fuel systems at pressures to 600 psi without qualification. The rate of effusion of gases and resistance to capillary leakage of fluid through the hose lines is controlled by a patented extrusion method used to produce Aeroquip PTFE hose liners.

Other Special Applications

Eaton's Aeroquip PTFE hose shown in this brochure is rated according to the listed specifications. These various ratings are for specific service conditions involving specified temperature, pressure and impulse conditions. In many cases, a specific rating can be successfully exceeded if other variables are modified. Thus, a higher operating pressure might be allowable if temperature and impulse life are modified or, similarly, operating temperature may be raised if pressure or surge conditions are reduced. Eaton's test facilities and Product Support Engineers are available to help with recommendations for special applications.

Hose in accordance with MIL-DTL-27267

Operating temperatures -65° to +450°F (-53°C to +232°C) (fluid and ambient)

Construction

- PTFE inner tube
- Stainless steel reinforcement

Reinforcement & Outer Cover

- 666 Hose – Type 300 Series stainless steel wire braid outer cover
- 667 Hose – two layers of Type 300 Series stainless steel wire braid

Identification

Identification bands showing specification number, manufacturer's code number, operating pressure and other required information.

Specification

Aeroquip medium pressure assemblies with 666 and 667 PTFE hose, "*super gem*" fittings and Compression Crimp fittings comply with MIL-H-25579 industry standard for 1500 psi (10,342.5 kPa), high temperature lines for aircraft and missile fluid systems and for ground support use.

Compression Crimp Fittings

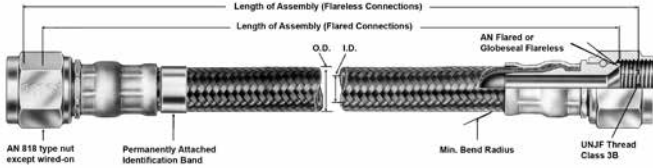

Compression Crimp Fittings For Use With Aeroquip 666/667 Medium Pressure PTFE Hose

Compression crimp fittings are available in both flared and flareless types to mate with (AS4395) and (AS4375) end connections. In addition, elbow fittings are available in standard 45° and 90° styles. Special elbows, crosses, tees, wyes, adapters, bosses, etc. may be made for customer installations.

The unique combination of the “ramped” nipple and the crimping pattern used on the compression crimp fitting results in superior fitting retention under pressure. Burst pressure tests indicate that extreme pressures will result in “free hose” bursts rather than fitting blow-off. The fitting design effectively traps and holds the wire reinforcement of the hose in the area of the ramp on the fitting nipple.



Fitting Standard Material Specifications:

Nut — CRES., AMS5639 (304)
Wire — CRES., AMS5685 (305)
Nipple — CRES., AMS5639 (304)
Socket — CRES., AMS5565 (304)

Dash Size†	Part Number	Hose I.D. (Min. inches/mm)	Hose O.D. (Max. Inches/mm)	Fluid Operating Pressure (psi/kPa)	Vacuum Data (Max. inches Hg/mm Hg)	Proof Pressure (psi/kPa)	Room Temp Min. Burst Pressure (psi/kPa)	Min. Bend Radius (inches/mm)	Weight Per Foot (lbs/kg)
-3	AE240-3	.125/3.17	.268/6.80	1500/10342	28/711	3000/20,684	7500/51,710	1.50/38	.041/.019
-4	666-4	.188/4.77	.343/8.71	1500/10342	28/711	3000/20,684	12,000/82,737	2.00/50	.084/.038
-5	666-5	.250/6.35	.406/10.31	1500/10342	28/711	3000/20,684	10,000/68,947	2.00/50	.105/.048
-6	666-6	.313/7.95	.469/11.91	1500/10342	28/711	3000/20,684	9000/62,052	4.00/101	.117/.053
-8	666-8	.406/10.31	.585/14.85	1500/10342	28/711	3000/20,684	8000/55,158	4.62/117	.163/.074
-10	666-10	.500/12.70	.687/17.44	1500/10342	28/711	3000/20,684	7000/48,263	5.50/139	.200/.091
-12	666-12	.630/16.00	.812/20.62	1000/6894	28*/711	2000/13,789	5000/34,473	6.50/165	.252/.114
-16	667-16	.878/22.30	1.140/28.95	1250/8618	28*/711	2500/17,236	5000/34,473	7.38/187	.525/.238

* With internal support coil, contact Eaton

† Also available in Non-Conductive Hose for gaseous and liquid oxidizing systems.

Flared Fittings

Socket
AE21498 (Code)



Sockets must be ordered separately under Eaton's Part Number AE21498 (letter size code same as nipple assembly)

	Hose	Nipple Assembly	Max A	B	C	Nom D	Min. H	F/R**	Thread T	Hex Y	Weight lbs/kg
<p>Straight</p>	AE204-3	AE21496B	1.12/28.4	.24/6.0	.34/8.6	-	.090/2.2	-	.3750-24	.50/12.70	.039/.017
	666-4*	AE21740E	1.10/27.9	.24/6.0	.34/8.6	-	.110/2.7	-	.3750-24	.50/12.70	.050/.022
	666-4	AE21496E	1.12/28.4	.25/6.3	.37/9.3	-	.132/3.3	-	.4375-20	.56/14.22	.050/.022
	666-5	AE21496F	1.26/32.0	.31/7.8	.38/9.6	-	.193/4.9	-	.5000-20	.62/15.74	.065/.029
	666-6	AE21496G	1.37/34.7	.34/8.6	.38/9.6	-	.256/6.5	-	.5625-18	.69/17.52	.078/.035
	666-8	AE21496H	1.53/38.8	.44/11.1	.43/10.9	-	.340/8.6	-	.7500-16	.88/22.35	.137/062
	666-10	AE21496J	1.75/44.5	.56/14.2	.50/12.7	-	.430/10.9	-	.8750-14	1.00/25.40	.191/.086
	666-12	AE21496K	1.96/49.7	.46/11.68	.57/14.4	-	.548/13.9	-	1.0625-12	1.25/31.75	.297/.134
	667-16	AE21496M	2.32/58.9	.60/15.2	.60/15.2	-	.778/19.7	-	1.3125-12	1.50/38.10	.464/.210
	<p>45° Elbow Forged</p>	AE240-3	AE21508B	1.53/38.8	.64/16.2	.34/8.6	.283/7.1	.090/2.2	.438/11.1	.3750-24	.50/12.70
666-4*		AE21924E	1.50/38.1	.62/15.7	.34/8.6	.283/7.1	.110/2.7	.438/11.1	.3750-24	.50/12.70	.055/.025
666-4		AE21508E	1.54/39.1	.66/16.7	.37/9.3	.322/8.1	.132/3.3	.438/11.1	.4375-20	.56/14.22	.065/.029
666-5		AE21508F	1.70/43.1	.74/18.7	.38/9.6	.334/8.4	.193/4.9	.562/14.2	.5000-20	.62/15.74	.098/.044
666-6		AE21508G	2.06/52.3	1.02/25.9	.38/9.6	.412/10.4	.256/6.5	.562/14.2	.5625-18	.69/17.52	.122/.055
666-8		AE21508H	2.19/55.6	1.08/27.4	.43/10.9	.465/11.8	.340/8.6	.625/15.8	.7500-16	.88/22.35	.185/.083
666-10		AE21508J	2.24/56.8	1.03/26.1	.50/12.7	.536/13.6	.430/10.9	.562/14.2	.8750-14	1.00/25.40	.208/.094
666-12		AE21508K	2.74/69.5	1.22/30.9	.57/14.4	.623/15.8	.548/13.9	.750/19.0	1.0625-12	1.25/31.75	.329/.149
667-16		AE21508M	3.11/78.9	1.36/34.5	.63/16.0	.660/16.7	.778/19.7	.906/23.0	1.3125-12	1.50/38.10	.492/.223
<p>45° Elbow Bent Tube</p>		AE240-3	AE21514B	1.30/33.0	.41/10.4	.34/8.6	.530/13.4	.090/2.2	.438/11.1	.3750-24	.50/12.70
	666-4*	AE21744E	1.28/32.5	.40/10.1	.34/8.6	.565/14.3	.110/2.7	.438/11.1	.3750-24	.50/12.70	.064/.029
	666-4	AE21514E	1.28/32.5	.40/10.1	.37/9.3	.580/14.7	.132/3.3	.438/11.1	.4375-20	.56/14.22	.071/.032
	666-5	AE21514F	1.57/39.8	.61/15.4	.38/9.6	.691/17.5	.193/4.9	.562/14.2	.5000-20	.62/15.74	.123/.055
	666-6	AE21514G	1.65/41.9	.61/15.4	.38/9.6	.750/19.0	.256/6.5	.562/14.2	.5625-18	.69/17.52	.132/.059
	666-8	AE21514H	1.72/43.6	.62/15.7	.43/10.9	.830/21.0	.340/8.6	.625/15.8	.7500-16	.88/22.35	.197/.089
	666-10	AE21514J	2.07/52.5	.86/21.8	.50/12.7	1.126/28.6	.430/10.9	.562/14.2	.8750-14	1.00/25.40	.220/.099
	666-12	AE21514K	2.61/66.2	1.09/27.6	.57/14.4	1.376/34.9	.548/13.9	.750/19.0	1.0625-12	1.25/31.75	.359/.162
	667-16	AE21514M	3.01/76.4	1.27/32.2	.63/16.0	1.500/38.1	.778/19.7	.906/23.0	1.3125-12	1.50/38.10	.523/.237
	<p>90° Elbow Bent Tube</p>	AE240-3	AE21514B	1.30/33.0	.41/10.4	.34/8.6	.530/13.4	.090/2.2	.438/11.1	.3750-24	.50/12.70
666-4*		AE21744E	1.28/32.5	.40/10.1	.34/8.6	.565/14.3	.110/2.7	.438/11.1	.3750-24	.50/12.70	.064/.029
666-4		AE21514E	1.28/32.5	.40/10.1	.37/9.3	.580/14.7	.132/3.3	.438/11.1	.4375-20	.56/14.22	.071/.032
666-5		AE21514F	1.57/39.8	.61/15.4	.38/9.6	.691/17.5	.193/4.9	.562/14.2	.5000-20	.62/15.74	.123/.055
<p>90° Elbow Forged</p>	666-6	AE21514G	1.65/41.9	.61/15.4	.38/9.6	.750/19.0	.256/6.5	.562/14.2	.5625-18	.69/17.52	.132/.059
	666-8	AE21514H	1.72/43.6	.62/15.7	.43/10.9	.830/21.0	.340/8.6	.625/15.8	.7500-16	.88/22.35	.197/.089
	666-10	AE21514J	2.07/52.5	.86/21.8	.50/12.7	1.126/28.6	.430/10.9	.562/14.2	.8750-14	1.00/25.40	.220/.099
	666-12	AE21514K	2.61/66.2	1.09/27.6	.57/14.4	1.376/34.9	.548/13.9	.750/19.0	1.0625-12	1.25/31.75	.359/.162
667-16	AE21514M	3.01/76.4	1.27/32.2	.63/16.0	1.500/38.1	.778/19.7	.906/23.0	1.3125-12	1.50/38.10	.523/.237	

Dimensions: inches/mm

Note: Fitting weights include sockets

Max. A = maximum length of fitting including socket when fitting is assembled on hose

B = dimension used to determine length of hose (hose cut factor)

Nom. D = nominal drop dimensions — Tolerance is ± .020" (.508 mm) on forged fittings and ± .035" (1.889 mm) on bent tube fittings.





* Jump Size. For use with -4 hose to mate with -3 connector.

** R = radius of elbow measure to centerline (bent tube)

F = distance across flats (forged)

Protective Sleeves

To use sleeves shown on this page with 666 Hose assemblies, please contact Eaton Aerospace Product Technical Support.

	Hose Size	Sleeve Size	Sleeve I.D.	Sleeve Gauge	Weight (lbs./kg)	
 Silicone Coated (Fibreglass) Firesleeve -65°F to +450°F (-53°C to +232°C)	AE102/666 (AS1072)	666-4	-8	.50/12.70	.125/3.17	.0093/.0042
	666-6	-11	.69/17.52	.125/3.17	.0131/.0059	
	666-8	-13	.81/20.57	.125/3.17	.0145/.0065	
	666-10	-14	.88/22.35	.125/3.17	.0155/.0070	
	666-12	-16	1.12/28.44	.125/3.17	.0200/.0090	
 Heat Shrinkable Polyolefin Abrasion Sleeve -65°F to +275°F (-53°C to +135°C)	AE251 (900961) (AS1073-B)	666-4	-2	.375/9.52	.030/.762	.0018/.0008
	666-6	-1	.375/9.52	.030/.762	.0018/.0008	
	666-8	-3	.500/12.70	.035/.889	.0028/.0012	
	666-10	-4	.500/12.70	.035/.889	.0028/.0012	
	666-12	-5	.750/19.05	.040/1.01	.0046/.0020	
 Nylon Spiral Wrap Abrasion Sleeve -65°F to +200°F (-53°C to +93°C)	AE208 (900005) (AS1294)	666-4	-4	.204/5.18	.023/.584	.0007/.0003
	666-6	-4	.204/5.18	.023/.584	.0007/.0003	
	666-8	-10	.436/11.07	.032/.812	.0020/.0009	
	666-10	-10	.436/11.07	.032/.812	.0020/.0009	
	666-12	-10	.436/11.07	.032/.812	.0020/.0009	
 Abrasion Sleeve made with Teflon™ FEP 100 fluoroplastic resin -65°F to +400°F (-53°C to +204°C)	AE506 (900179) (AS1291-C)	666-4	-9	.421/10.69	.018/.457	.0017/.0007
	666-6	-11	.484/12.29	.018/.457	.0019/.0008	
	666-8	-13	.600/15.24	.018/.457	.0024/.0010	
	666-10	-14	.702/17.83	.018/.457	.0028/.0012	
	666-12	-17	.945/24.00	.018/.457	.0037/.0016	
 Neoprene Tubing Abrasion Sleeve -65°F to +250°F (-53°C to +121°C)	AE138 (646) (AS1295)	666-4	-4	.328/8.33	.035/.889	.0020/.0009
	666-6	-8	.453/11.50	.035/.889	.0029/.0013	
	666-8	-12	.562/14.27	.040/1.01	.0039/.0017	
	666-10	-16	.671/17.04	.040/1.01	.0046/.0020	
	666-12	-22	.843/21.41	.050/1.27	.0072/.0032	

Dimensions: inches/mm

NOTE: Use an abrasion sleeve with AE666 PTFE hose in any application where the braid is subject to possible abrasion. Eaton offers two sleeve styles: AE566 hose with integral polyester chafeguard and AE466 hose with integral silicone firesleeve. See pages 25–28 on the integral polyester chafeguard and pages 29–31 for the integral silicone firesleeve. For more information on these advanced hose styles, contact your nearest Eaton distributor or Eaton sales representative.

Hose Assemblies/Swivel Flared to Swivel Flared

All hose assemblies shown on this page conform to MS8005. MS style code indicates configuration and material in accordance with MIL-DTL-25579

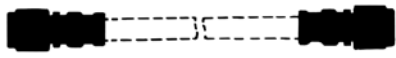
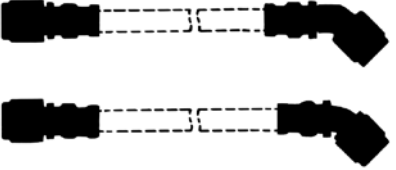
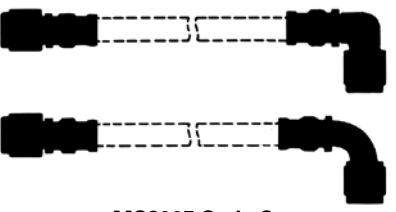
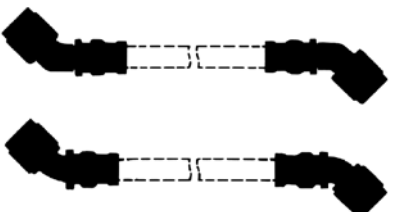
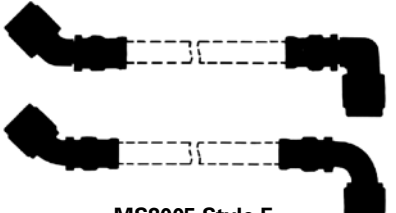
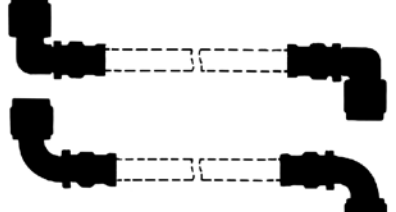
A	B	Dash Size	Material	Assembly Base No.	MS Style Code	Nipple A Part No.	Nipple B Part No.
 MS8005 Style A		-3 -4	CRES	AE3660240	A	AE21740	AE21740
		-3 thru -12	CRES	AE3660000	A	AE21496	AE21496
		-16	CRES	AE3660000	A	AE21496	AE21496
 MS8005 Style B	Forged Bent Tube	-3 -4	CRES	AE3660250	B	AE21740	AE21924
		-3 thru -8	CRES	AE3660060	B	AE21496	AE21508
		-10 thru -16	CRES	AE3660060	B	AE21496	AE21508
 MS8005 Style C	FORGED BENT TUBE	-3 -4	CRES	AE3660300	C	AE21740	AE21744
		-3 thru -8	CRES	AE3660120	C	AE21496	AE21514
		-10 thru -16	CRES	AE3660120	C	AE21496	AE21514
 MS8005 Style D	FORGED BENT TUBE	-3 -4	CRES	AE6139	D	AE21924	AE21924
		-3 thru -8	CRES	AE6000	D	AE21508	AE21508
		-10 thru -16	CRES	AE6000	D	AE21508	AE21508
 MS8005 Style E	FORGED BENT TUBE	-3 -4	CRES	AE6140	E	AE21924	AE21744
		-3 thru -8	CRES	AE6020	E	AE21508	AE21514
		-10 thru -16	CRES	AE6020	E	AE21508	AE21514
 MS8005 Style F	FORGED BENT TUBE	-3 -4	CRES	AE6141	F	AE21744	AE21744
		-3 thru -8	CRES	AE6040	F	AE21514	AE21514
		-10 thru -16	CRES	AE6040	F	AE21514	AE21514

Globeseal® Flareless Fittings

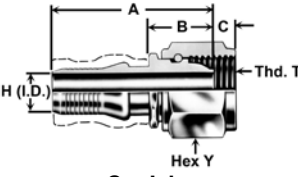
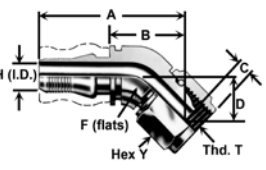
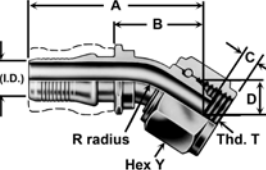
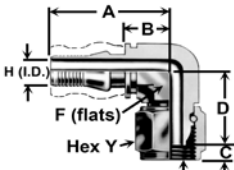
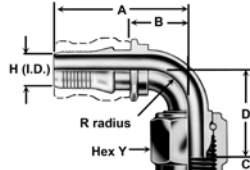
	Hose	Nipple Assembly	Max A (see notes)	B	C	Nom D	
 <p>Straight</p>	AE240-3	AE21502B	1.34/34.03	0.47/11.93	0.12/3.04	–	
	666-4*	AE21742E	1.34/34.03	0.48/12.19	0.12/3.04	–	
	666-4	AE21502E	1.34/34.03	0.47/11.93	0.17/4.31	–	
	666-5	AE21502F	1.49/37.84	0.54/13.71	0.15/3.81	–	
	666-6	AE21502G	1.60/40.64	0.57/14.47	0.16/4.06	–	
	666-8	AE21502H	1.82/46.22	0.73/18.54	0.18/4.57	–	
	666-10	AE21502J	2.06/52.32	0.88/22.35	0.20/5.08	–	
	666-12	AE21502K	2.40/60.96	0.91/23.11	0.20/5.08	–	
	667-16	AE21502M	2.84/72.13	1.12/28.44	0.13/3.03	–	
	 <p>45° Elbow Forged</p>	AE240-3	AE21511B	1.70/43.18	0.82/20.82	0.12/3.04	0.455/11.55
666-4*		AE21925E	1.67/42.41	0.79/20.06	0.12/3.04	0.451/11.45	
666-4		AE21511E	1.70/43.18	0.82/20.82	0.17/4.31	0.480/12.19	
666-5		AE21511F	1.87/47.49	0.90/22.86	0.15/3.81	0.499/12.67	
666-6		AE21511G	2.22/56.38	1.18/29.97	0.16/4.06	0.570/14.47	
666-8		AE21511H	2.39/60.70	1.28/32.51	0.18/4.57	0.668/16.96	
 <p>45° Elbow Bent Tube</p>		666-10	AE21511J	2.49/63.24	1.29/32.76	0.20/5.08	0.793/20.14
		666-12	AE21511K	3.05/77.47	1.53/38.86	0.20/5.08	0.934/23.72
		667-16	AE21511M	3.50/88.90	1.75/44.45	0.13/3.30	1.051/26.69
		 <p>90° Elbow Forged</p>	AE240-3	AE21517B	1.30/33.02	0.41/10.41	0.12/3.04
666-4*	AE21926E		1.28/32.51	0.40/10.16	0.12/3.04	0.808/20.52	
666-4	AE21517E		1.28/32.51	0.40/10.16	0.17/4.31	0.800/20.32	
666-5	AE21517F		1.57/39.87	0.61/15.49	0.15/3.81	0.924/23.46	
666-6	AE21517G		1.65/41.91	0.61/15.49	0.16/4.03	0.978/24.84	
666-8	AE21517H		1.72/43.68	0.62/15.74	0.18/4.57	1.121/28.47	
 <p>90° Elbow Bent Tube</p>	666-10		AE21517J	2.07/52.57	0.86/21.84	0.20/5.08	1.477/37.51
	666-12		AE21517K	2.61/66.29	1.09/27.68	0.20/5.08	1.816/46.12
	667-16		AE21517M	3.01/76.45	1.27/32.25	0.13/3.30	2.054/52.17

Dimensions: inches/mm

Max. A = maximum length of fitting including socket when fitting is assembled on hose

B = dimension used to determine length of hose (hose cut factor)

Nom. D = nominal drop dimensions —

Tolerance is ± .020" (.508mm) on forged fittings and ± .035" (.889 mm) on bent tube fittings.

* Jump Size. For use with -4 hose to mate with -3 connector.

Socket
AE21498
(Code)



Socket must be ordered separately under Eaton's Part Number AE21498) (letter size code same as nipple assembly

Distance
to Sealing
Points

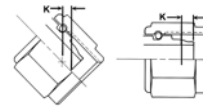

K = gauge point
location per NAS
1760

	Dash Size	Min. H	K	F/R**	Thread T	Hex Y	Weight lbs/kg
STRAIGHT FLARELESS	-3	0.0908/2.28	0.14/3.55	-	.3750-24	0.50/12.70	0.038/.017
	-4*	0.112/2.84	0.14/3.55	-	.3750-24	0.50/12.70	0.040/.018
	-4	0.132/3.35	0.16/4.06	-	.4375-20	0.56/14.22	0.055/.024
	-5	0.193/4.90	0.16/4.06	-	.5000-20	0.62/15.74	0.068/.030
	-6	0.256/6.50	0.16/4.06	-	.5625-18	0.69/17.52	0.095/.043
	-8	0.340/8.63	0.19/4.82	-	.7500-16	0.88/22.35	0.157/.071
	-10	0.430/10.92	0.20/5.08	-	.875-14	1.00/25.40	0.211/.095
	-12	0.548/13.91	0.23/5.84	-	1.0625-12	1.25/31.75	0.347/.157
	-16	0.778/19.76	0.30/7.62	-	1.3125-12	1.50/38.10	0.496/.224
45° FLARELESS	-3	0.090/2.28	0.10/2.54	0.438/11.12	.3750-24	0.50/12.70	0.052/.023
	-4*	0.112/2.84	0.10/2.54	0.438/11.12	.3750-24	0.50/12.70	0.059/.026
	-4	0.132/3.35	0.11/2.79	0.438/11.12	.4375-20	0.56/14.22	0.077/.034
	-5	0.193/4.90	0.11/2.79	0.562/14.27	.5000-20	0.62/15.74	0.102/.046
	-6	0.256/6.50	0.12/3.04	0.562/14.27	.5625-18	0.69/17.52	0.142/.064
	-8	0.340/8.63	0.13/3.30	0.625/15.87	.7500-16	0.88/22.35	0.214/.097
	-10	0.430/10.92	0.14/3.55	0.562/14.27	.875-14	1.00/25.40	0.222/.100
	-12	0.548/13.91	0.16/4.06	0.750/19.05	1.0625-12	1.25/31.75	0.352/.159
	-16	0.778/19.76	0.21/5.33	0.906/23.01	1.3125-12	1.50/38.10	0.540/.244
90° FLARELESS	-3	0.090/2.28	-	0.438/11.12	.3750-24	0.50/12.70	0.058/.026
	-4*	0.112/2.84	-	0.438/11.12	.3750-24	0.50/12.70	0.068/.030
	-4	0.132/3.35	-	0.438/11.12	.4375-20	0.56/14.22	0.082/.037
	-5	0.193/4.90	-	0.562/14.27	.5000-20	0.62/15.74	0.126/.057
	-6	0.256/6.50	-	0.562/14.27	.5625-18	0.69/17.52	0.153/.069
	-8	0.340/8.63	-	0.625/15.87	.7500-16	0.88/22.35	0.224/.101
	-10	0.430/10.92	-	0.562/14.27	.875-14	1.00/25.40	0.238/.107
	-12	0.548/13.91	-	0.750/19.05	1.0625-12	1.25/31.75	0.401/.181
	-16	0.778/19.76	-	0.906/23.01	1.3125-12	1.50/38.10	0.572/.259

Dimensions: inches/mm

Note: Fitting weights include sockets

*Jump Size. For use with -4 hose to mate with -3 connector.



** R = radius of elbow measure to centerline (bent tube)

F = distance across flats (forged)

Refer to images on previous page.

Hose Assemblies/Swivel Flareless to Swivel Flareless

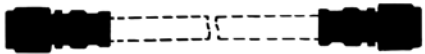
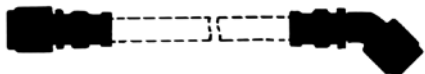
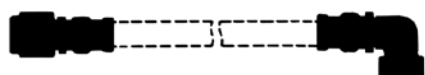
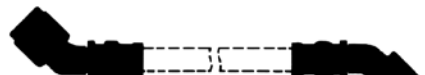
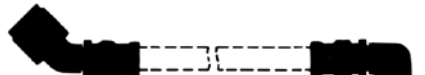
All hose assemblies shown on this page conform to MS8006.
MS style code indicates configuration and material. In accordance with MIL-DTL-25579

A	B	Dash Size	Material	Assembly Base No.	MS Style Code	Nipple A Part No.	Nipple B Part No.
 MS8006 Style A		-3 -4	CRES	AE3660310	A	AE21742	AE21742
		-4 thru -12	CRES	AE3660010	A	AE21502	AE21502
		-16	CRES	AE3660010	A	AE21502	AE21502
 MS8006 Style B	FORGED BENT TUBE	3- -4	CRES	AE3660315	B	AE21742	AE21925
		-4 thru -8	CRES	AE3660070	B	AE21502	AE21511
		-10 thru -16	CRES	AE3660070	B	AE21502	AE21511
 MS8006 Style C	FORGED BENT TUBE	-3 -4	CRES	AE3660325	C	AE21742	AE21926
		-4 thru -8	CRES	AE3660130	C	AE21502	AE21517
		-10 thru -16	CRES	AE3660130	C	AE21502	AE21517
 MS8006 Style D	FORGED BENT TUBE	-3 -4	CRES	AE6138	D	AE21925	AE21925
		-4 thru -8	CRES	AE6060	D	AE21511	AE21511
		-10 thru -16	CRES	AE6060	D	AE21511	AE21511
 MS8006 Style E	FORGED BENT TUBE	-3 -4	CRES	AE6137	E	AE21925	AE21926
		-4 thru -8	CRES	AE6080	E	AE21511	AE21517
		-10 thru -16	CRES	AE6080	E	AE21511	AE21517
 MS8006 Style F	FORGED BENT TUBE	-3 -4	CRES	AE6136	F	AE21926	AE21926
		-4 thru -8	CRES	AE6100	F	AE21517	AE21517
		-10 thru -16	CRES	AE6100	F	AE21517	AE21517

How To Complete Hose Assembly Part Number

Basic Assembly Numbers

The basic part number shown here represents standard configurations with materials, markings, and cleaning requirements confirming to MIL-DTL-25579. If your requirements differ from these standards, the hose assemblies you order will be assigned new number by Eaton.

Rotational Angle Measurement

On assemblies with an elbow fitting on each end, measure the position angle as shown above and suffix the angle to the basic style number. In all cases, the angle should be expressed in 3 digits. For example, 35° should be written as 035. If the angle desired is 0°, specify 000.

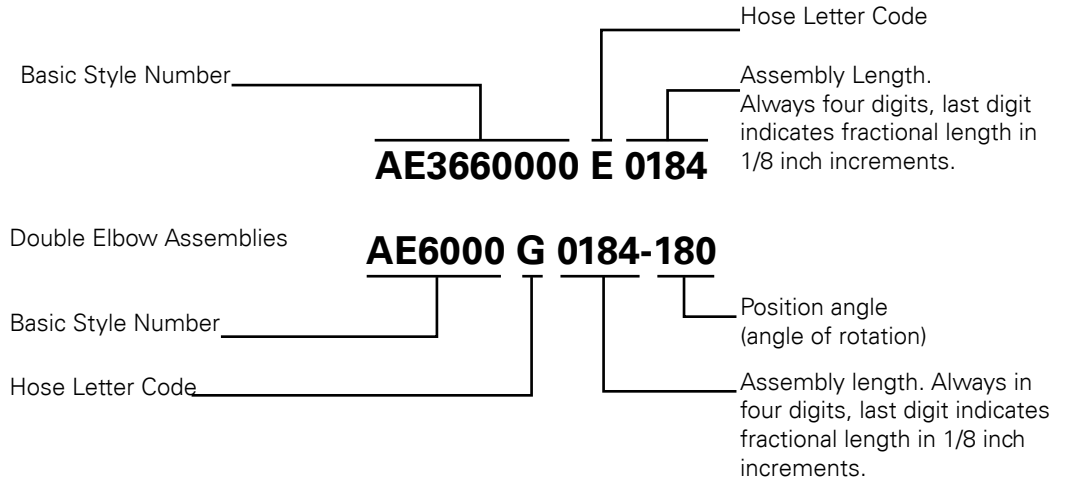

Hose Dash Size	3	4	5	6	8	10	12	16
Letter Code	B	E	F	G	H	J	K	M

Sample Part Number

Straight and single elbow assemblies.

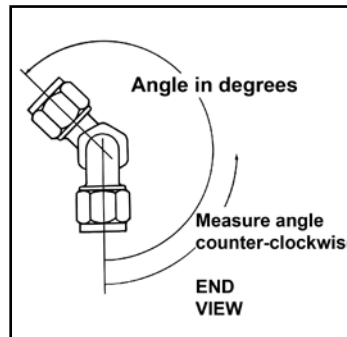

"super gem" Reusable Fittings

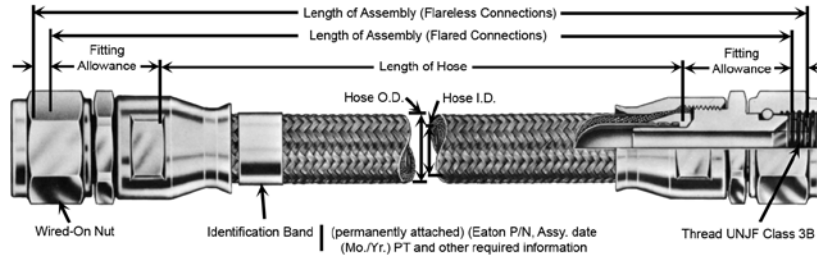

In Accordance with MIL-DTL-27272

The "super gem" fitting provides permanent protection against leakage, even after high temperature aging and impulsing. The reason for this performance lies in the separation of the sealing function from the retention function. A lip seal is formed by the separation of the PTFE tube in an annular chamber, while positive grip on the wire reinforcement between socket and nipple sleeve provides permanent protection against fitting blow-off.

It has a dry lube (Molybdenum disulfide) coating on thread and sealing surfaces. This is a permanent coating and requires no additional lubrication during assembly. It is designed for assembly to gap dimension, which indicates proper assembly. It is available in both flared and flareless types to mate with AS4395 and AS4375 end connections. In addition, elbow fittings are available in standard 45° and 90° styles. Special elbows, crosses, tees, eyes, adapters, bosses, etc. may be made for customer installations.

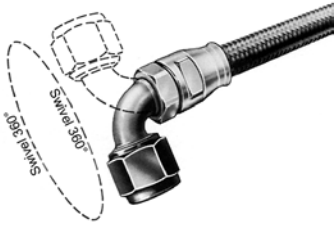

Adjustable Elbows

"super gem" adjustable elbow fittings are easily positioned through 360° to the desired relative angle between opposite elbow fittings. Mock-up and prototype installation changes are simplified, as the position angle can be determined on the actual installation.

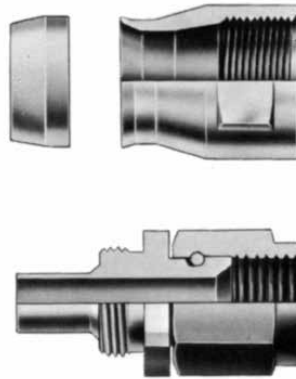

3-Piece Fitting

The Eaton Aeroquip medium pressure "super gem" reusable fitting consist of 3 pieces:

- Socket
- Sleeve
- Nipple Assembly

"super gem" fitting standard material specifications	Nut — CRES., SAE-AMS-QQ-S-763 (304)
	Wire — CRES., SAE-AMS-QQ-S-763 (305)
	Nipple — CRES., SAE-AMS-QQ-S-763 (304)
	Socket — CRES., SAE-AMS-QQ-S-763 (304)

Dash Size	Part Number	Hose I.D. (inches/mm)	Hose O.D. (inches/mm)	Fluid Operating Pressure (psi/kPa)	Vacuum Data (Max. inches Hg/mm Hg)	Proof Pressure (psi/kPa)	Room Temp Min. Burst Pressure (psi/kPa)	Min. Bend Radius (inches/mm)	Weight per Foot (lbs/kg)
-3†	AE240-3	.125/3.175	.250/6.3	1500/10342	28/711	3000/20684	12000/82737	1.50/38	.041/.019
-4	666-4	.188/4.77	.312/7.9	1500/10342	28/711	3000/20684	12000/82737	2.00/50.8	.084/.038
-5	666-5	.250/6.35	.375/9.5	1500/10342	28/711	3000/20684	10000/68947	2.00/50.8	.105/.048
-6	666-6	.313/7.9	.466/11.8	1500/10342	28/711	3000/20684	9000/62052	4.00/101.6	.117/.053
-8	666-8	.406/10.3	.562/14.2	1500/10342	28/711	3000/20684	8000/55158	4.62/117.3	.163/.074
-10	666-10	.500/12.7	.656/16.6	1500/10342	28/711	3000/20684	7000/48263	5.50/139.7	.200/.091
-12	666-12	.625/15.87	.789/20	1000/10342	28*/711	2000/13789	5000/34473	6.50/165.1	.252/.114
-16	667-16	.875/22.22	1.109/28.1	1250/10342	28*/711	2500/17236	5000/34473	7.38/187.4	.525/.238
-20	667-20	1.125/28.5	1.359/34.5	1000/6894	28*/711	2000/13789	4000/27579	11.00/279.4	.662/.300
-24	667-24	1.375/34.9	1.672/42.4	1000/6894	28*/711	2000/13789	4000/27579	14.00/355.5	.893/.405

* With internal support coil, contact Eaton

† Non-Conductive Hose also available in other sizes for gaseous and liquid oxidizing systems.

"super gem" Swivel Fittings

Fittings in accordance with MIL-DTL-27272

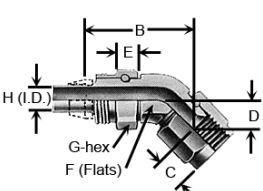
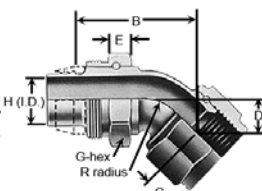
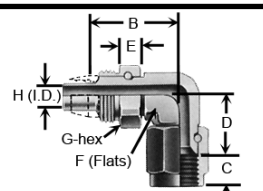
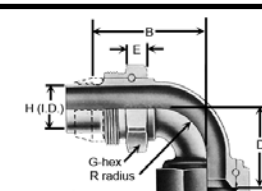
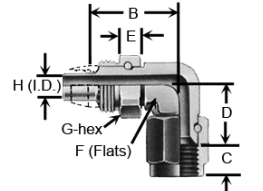
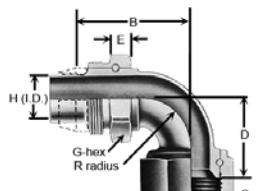
	ALUM Series			CRES Series								
	Hose	Nipple	Fitting Assembly	Nipple	Fitting Assembly							
Straight Flared Swivel (mates with AS4395)												
 <p>MS27061 nipple *MS27053 fitting assembly</p>	AE240-3			G65000-3	F66000-3							
	666-4	G65008-4	F66826-4	G65000-4	F66000-4							
	666-5	G65008-5	F66826-5	G65000-5	F66000-5							
	666-6	G65008-6	F66826-6	G65000-6	F66000-6							
	666-8	G65008-8	F66826-8	G65000-8	F66000-8							
	666-10	G65008-10	F66826-10	G65000-10	F66000-10							
	666-12	G65008-12	F66826-12	G65000-12	F66000-12							
	667-16	G65058-16	F66821-16	G65057-16	F66057-16							
	667-20	G65058-20	F66821-20	G65057-20	F66057-20							
	667-24	G65058-24	F66821-24	G65057-24	F66057-24							
Globeseal Flareless Swivel (mates with AS4375)												
 <p>MS27386 nipple *MS27381 fitting assembly</p>	AE240-3			G65018-3	F66018-3							
	666-4	G65016-4	F66840-4	G65018-4	F66018-4							
	666-5	G65016-5	F66840-5	G65018-5	F66018-5							
	666-6	G65016-6	F66840-6	G65018-6	F66018-6							
	666-8	G65016-8	F66840-8	G65018-8	F66018-8							
	666-10	G65016-10	F66840-10	G65018-10	F66018-10							
	666-12	G65016-12	F66840-12	G65018-12	F66018-12							
	667-16	G67022-16	F62024-16	G67023-16	F68023-16							
	667-20	G67022-20	F62024-20	G67023-20	F68023-20							
	667-24	G67022-24	F62024-24	G67023-24	F68023-24							
Flared Elbows (adjustable)												
 <p>45° MS27067 nipple *MS27059 fitting assembly</p>	 <p>MS27063 nipple *MS27055 fitting assembly</p>	FORGED		AE240-3	G6533-3	F6633-3						
				666-4	G6529-4	F66555-4	G6533-4	F6633-4				
				666-5	G6529-5	F66555-5	G6533-5	F6633-5				
				666-6	G6529-6	F66555-6	G6533-6	F6633-6				
				666-8	G6529-8	F66555-8	G6533-8	F6633-8				
				 <p>90° MS27068 nipple *MS27060 fitting assembly</p>	 <p>MS27065 nipple *MS27057 fitting assembly</p>	BENT TUBE		666-10	G6530-10	F66532-10	G6534-10	F6634-10
								666-12	G6530-12	F66532-12	G6534-12	F6634-12
								667-16	G6563-16	F66533-16	G6562-16	F6679-16
								667-20	G6563-20	F66533-20	G6562-20	F6679-20
								667-24	G6563-24	F66533-24	G6562-24	F6679-24
FORGED												
BENT TUBE												
FORGED												
BENT TUBE												
FORGED												
BENT TUBE												
FORGED												
BENT TUBE												
FORGED												
BENT TUBE												
FORGED												
BENT TUBE												
FORGED												
BENT TUBE												

*Add — (size) to MS number. If material is to be CRES, add suffix "C" to size.

“super gem” Swivel Fittings

Fittings in accordance with MIL-DTL-27272

Refer to images on previous page.

	Dash Size	-----Weight----- (lbs./kg)		Max. A	Fitting Cut-Off B	C	Nominal D	E	F	G
		CRES	Alum							
STRAIGHT, FLARED	-3	.047/.021	.024/.010	1.15/29.21	.70/17.78	.34/8.63	-	.12/3.04	-	.50/12.70
	-4	.069/.031	.038/.017	1.35/34.29	.74/18.79	.37/9.39	-	.12/3.04	-	.56/14.22
	-5	.086/.039	.046/.020	1.41/35.81	.77/19.55	.38/9.65	-	.12/3.04	-	.62/15.74
	-6	.106/.048	.057/.025	1.47/37.33	.81/20.57	.38/9.65	-	.14/3.55	-	.69/17.52
	-8	.198/.089	.111/.050	1.70/43.18	.93/23.62	.43/10.92	-	.15/3.81	-	.88/22.35
	-10	.283/.128	.157/.071	1.86/47.24	1.05/26.67	.50/12.70	-	.17/4.31	-	1.00/25.40
	-12	.374/.016	.196/.088	1.93/19.02	1.13/28.70	.57/14.47	-	.19/4.82	-	1.25/31.75
	-16	.658/.298	.345/.156	2.15/54.61	1.30/33.02	.60/15.24	-	.22/5.58	-	1.50/38.10
	-20	1.085/.492	.606/.274	2.52/64.00	1.44/36.57	.64/16.25	-	.28/7.11	-	1.81/45.97
	-24	1.742/.790	.880/.399	2.71/68.83	1.66/42.16	.74/18.79	-	.28/7.11	-	2.12/53.84
STRAIGHT, FLARELESS	-3	.048/.021	.017/.007	1.37/34.79	.92/23.36	.13/3.30	-	.22/5.58	-	.44/11.17
	-4	.072/.032	.022/.010	1.50/38.10	.89/22.60	.22/5.58	-	.23/5.84	-	.56/14.22
	-5	.900/.408	.038/.017	1.57/39.87	.93/23.62	.22/5.58	-	.25/6.35	-	.62/15.74
	-6	.114/.051	.044/.020	1.68/42.67	1.02/25.90	.19/4.82	-	.27/6.85	-	.69/17.52
	-8	.210/.095	.080/.036	1.92/48.76	1.16/29.46	.21/5.33	-	.31/7.87	-	.88/22.35
	-10	.305/.138	.093/.042	2.14/54.35	1.32/33.52	.24/6.09	-	.31/7.87	-	1.00/25.40
	-12	.452/.205	.164/.074	2.21/56.13	1.40/35.56	.31/7.87	-	.36/9.14	-	1.12/28.44
	-16	.677/.307	.250/.113	2.42/61.46	1.58/40.13	.32/8.12	-	.41/10.41	-	1.50/38.10
	-20	1.187/.538	.396/.179	2.79/70.86	1.72/43.68	.37/9.39	-	.44/11.17	-	1.81/45.97
	-24	1.680/.762	.646/.293	3.09/78.48	2.07/52.57	.33/8.38	-	.50/12.70	-	2.12/53.84
45° FLARED	3	.055/.024	.030/.013	1.55/39.37	1.08/27.43	.34/8.63	.283/7.18	.22/5.58	.44/11.17	.44/11.17
	-4	.079/.035	.055/.024	1.81/45.97	1.18/29.97	.37/9.39	.322/8.17	.23/5.84	.44/11.17	.56/14.22
	-5	.106/.048	.070/.031	1.88/47.75	1.22/30.98	.38/9.65	.340/8.63	.25/6.35	.56/14.22	.62/15.74
	-6	.125/.056	.080/.036	1.97/50.03	1.29/32.76	.38/9.65	.389/9.88	.27/6.85	.56/14.22	.69/17.52
	-8	.241/.109	.144/.065	2.58/65.53	1.79/45.46	.43/10.92	.465/11.81	.31/7.87	.62/15.74	.88/22.35
	-10	.319/.144	.178/.080	2.43/61.72	1.58/40.13	.50/12.70	.536/13.61	.31/7.87	-	1.00/25.40
	-12	.480/.217	.249/.112	2.89/73.40	2.05/52.07	.57/14.47	.623/15.82	.36/9.14	-	1.12/28.44
	-16	.758/.343	.404/.183	3.02/76.70	2.14/54.35	.63/16.00	.660/16.76	.41/10.41	-	1.50/38.10
	-20	1.223/.554	.63/.288	3.52/89.40	2.42/61.46	.64/16.25	.768/19.50	.44/11.17	-	1.81/45.97
	-24	1.828/.829	.736/.333	3.83/97.28	2.75/69.85	.77/19.55	.867/22.02	.50/12.70	-	2.12/53.84
90° FLARED	-3	.073/.033	.036/.016	1.33/33.78	.86/21.84	.34/8.63	.530/13.46	.22/5.58	.44/11.17	.44/11.17
	-4	.098/.044	.056/.025	1.54/39.11	.91/23.11	.37/9.39	.580/14.73	.23/5.84	.44/11.17	.56/14.22
	-5	.138/.062	.075/.034	1.63/41.40	.97/24.63	.38/9.65	.655/16.63	.25/6.35	.56/14.22	.62/15.74
	-6	.160/.072	.091/.041	1.71/43.43	1.03/26.16	.38/9.65	.720/18.28	.27/6.87	.56/14.22	.69/17.52
	-8	.288/.130	.148/.067	2.09/53.08	1.31/33.27	.43/10.92	.830/21.08	.31/7.87	.62/15.74	.88/22.35
	-10	.331/.150	.180/.081	2.26/57.40	1.41/35.81	.50/12.70	1.126/28.60	.31/7.87	-	1.00/25.40
	-12	.498/.041	.262/.118	2.76/70.10	1.92/48.76	.57/14.47	1.376/34.95	.36/9.14	-	1.12/28.44
	-16	.786/.356	.419/.190	2.93/74.42	2.05/52.07	.63/16.00	1.500/38.10	.41/10.41	-	1.50/38.10
	-20	1.272/.577	.659/.298	3.45/87.63	2.34/59.43	.64/13.25	1.782/45.26	.44/11.17	-	1.81/45.97
	-24	1.922/.871	.749/.339	3.77/95.75	2.68/68.07	-	2.032/51.61	.50/12.70	-	2.12/53.84

All dimensions in inches/mm.

Nom. D = nominal drop dimensions - Tolerance is ± .020" (.508 mm) on forged fittings and ± .035" (.889 mm) on bent tube fittings.

F = distance across forging flats

Socket: Flat
 MS27069 -(size) C
 666 Hose: F506-(size) C
 667 Hose: F756-(size) C

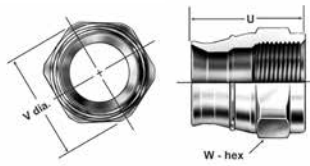

Sleeve
 MS27070 -(size) C
 666 Hose: 900767-(size) C
 667 Hose: 900867-(size) C

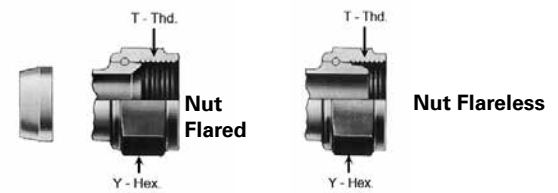

Refer to images on page 13.

	-----Socket-----						-----Nut-----	
	Dash Size	Min. H	R	U	V	W	Thread T	Hex Y
STRAIGHT, FLARED	-3	.090/2.28	-	.62 5/15.74	.505/13.20	.438/11.17	.3750-24 UNJF-3B	.490/12.70
	-4	.161/4.08	-	.806/20.57	.649/16.76	.562/14.22	.4375-20 UNJF-3B	.557/14.22
	-5	.224/5.68	-	.834/21.08	.722/18.54	.625/15.74	.5000-20 UNJF-3B	.620/15.74
	-6	.261/6.62	-	.853/21.59	.791/20.57	.688/17.52	.5625-18 UNJF-3B	.692/17.52
	-8	.345/8.76	-	.979/24.89	1.010/25.90	.875/22.35	.7500-16 UNJF-3B	.870/22.35
	-10	.440/11.17	-	1.080/27.43	1.155/29.71	1.00/25.40	.8750-14 UNJF-3B	.995/25.40
	-12	.560/14.22	-	1.152/29.21	1.299/33.27	1.125/28.44	1.0625-12 UNJ-3B	1.253/31.75
	-16	.828/21.03	-	1.255/32.00	1.732/44.19	1.50/31.80	1.3125-12 UNJ-3B	1.495/31.80
	-20	1.058/26.87	-	1.510/38.35	2.165/55.37	1.875/47.75	1.6250-12 UNJ-3B	1.812/45.97
	-24	1.282/32.51	-	1.582/40.13	2.454/62.48	2.125/53.84	1.8750-12 UNJ-3B	2.125/53.84
STRAIGHT, FLARELESS	-3	.090/2.28	-	.625/15.74	.505/13.20	.438/11.17	.3750-24 UNJF-3G	.490/12.70
	-4	.161/4.08	-	.806/20.57	.649/16.76	.562/14.22	.4375-20 UNJF-3G	.557/14.22
	-5	.224/5.68	-	.834/21.08	.722/18.54	.625/15.74	.5000-20 UNJF-3G	.620/15.74
	-6	.261/6.62	-	.853/21.59	.791/20.57	.688/17.52	.5625-18 UNJF-3G	.682/17.52
	-8	.345/8.76	-	.979/24.89	1.010/25.90	.875/22.35	.7500-16 UNJF-3G	.870/22.35
	-10	.440/11.17	-	1.080/27.43	1.155/29.71	1.00/25.40	.8750-14 UNJF-3G	.995/25.40
	-12	.560/14.22	-	1.152/29.21	1.299/33.27	1.125/28.44	1.0625-12 UNJ-3B	1.245/31.75
	-16	.828/21.03	-	1.255/32.00	1.732/44.19	1.50/31.80	1.3125-12 UNJ-3B	1.495/31.80
	-20	1.058/26.87	-	1.510/38.35	2.165/55.37	1.875/47.75	1.6250-12 UNJ-3B	1.812/45.97
	-24	1.282/32.51	-	1.582/40.13	2.454/62.48	2.125/53.84	1.8750-12 UNJ-3B	2.125/53.84
45° FLARED	3	.090/2.28	-	.625/15.74	.505/13.20	.438/11.17	.3750-24 UNJF-3B	.490/12.70
	-4	.160/4.06	-	.806/20.57	.649/16.76	.562/14.22	.4375-20 UNJF-3B	.557/14.22
	-5	.220/5.58	-	.834/21.08	.722/18.54	.625/15.74	.5000-20 UNJF-3B	.620/15.74
	-6	.261/6.62	-	.853/21.59	.791/20.57	.688/17.52	.5625-18 UNJF-3B	.682/17.52
	-8	.345/8.76	-	.979/24.89	1.010/25.90	.875/22.35	.7500-16 UNJF-3B	.870/22.35
	-10	.440/11.17	.62/15.74	1.080/27.43	1.155/29.71	1.00/25.40	.8750-14 UNJF-3B	.995/25.40
	-12	.560/14.22	.84/21.33	1.152/29.21	1.299/33.27	1.125/28.44	1.0625-12 UNJ-3B	1.245/31.75
	-16	.828/21.03	.97/24.63	1.255/32.00	1.732/44.19	1.50/31.80	1.3125-12 UNJ-3B	1.495/31.80
	-20	1.058/26.87	1.19/30.22	1.510/38.35	2.165/55.37	1.875/47.75	1.6250-12 UNJ-3B	1.812/45.97
	-24	1.253/31.82	1.38/35.05	1.580/40.13	2.454/62.48	2.125/53.84	1.8750-12 UNJ-3B	2.125/53.84
90° FLARED	-3	.090/2.28	-	.625/15.74	.505/13.20	.438/11.17	.3750-24 UNJF-3B	.490/12.70
	-4	.160/4.06	-	.806/20.57	.649/16.76	.562/14.22	.4375-20 UNJF-3B	.557/14.22
	-5	.220/5.58	-	.834/21.08	.722/18.54	.625/15.74	.5000-20 UNJF-3B	.620/15.74
	-6	.261/6.62	-	.853/21.59	.791/20.57	.688/17.52	.5625-18 UNJF-3B	.682/17.52
	-8	.345/8.76	-	.979/24.89	1.010/25.90	.875/22.35	.7500-16 UNJF-3B	.870/22.35
	-10	.440/11.17	.62/15.74	1.080/27.43	1.155/29.71	1.00/25.40	.8750-14 UNJF-3B	.995/25.40
	-12	.560/14.22	.84/21.33	1.152/29.21	1.299/33.27	1.125/28.44	1.0625-12 UNJF-3B	1.245/31.75
	-16	.828/21.03	.97/24.63	1.255/32.00	1.732/44.19	1.50/31.80	1.3125-12 UNJ-3B	1.495/31.80
	-20	1.058/26.87	1.19/30.22	1.510/38.35	2.165/55.37	1.875/47.75	1.6250-12 UNJ-3B	1.812/45.97
	-24	1.253/31.82	1.38/35.05	1.580/40.13	2.454/62.48	2.125/53.84	1.8750-12 UNJ-3B	2.125/53.84

Dimensions: inches/mm
 R = radius of elbow measured to center line

"super gem" Swivel Nut Globeseal Flareless & 4 Hole Flanged Elbows Fittings in accordance with MIL-DTL-27272

Globeseal Flareless Elbows

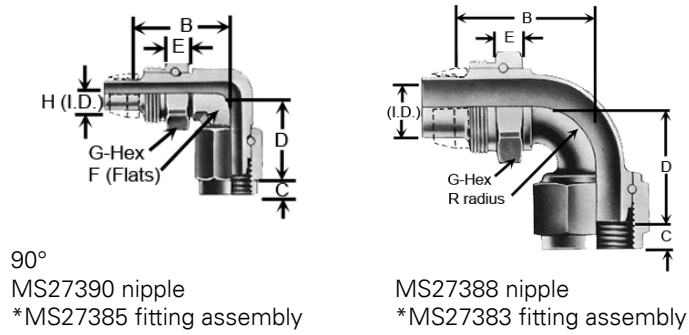
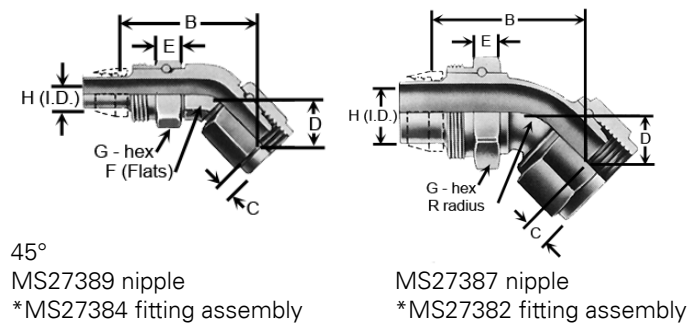

	ALUM Series			CRES Series		
	Hose	Nipple	Fitting Assy.	Nipple	Fitting Assy.	
FORGED	AE240-3			G65113-3	F66113-3	
	666-4	G65114-4	F62124-4	G65113-4	F66113-4	
	666-5	G65114-5	F62124-5	G65113-5	F66113-3	
	666-6	G65114-6	F62124-6	G65113-6	F66113-6	
	666-8	G65114-8	F62124-8	G65113-8	F66113-8	
	BENT TUBE	666-10	G65102-10	F62148-10	G65101-10	F66101-10
		666-12	G65102-12	F62148-12	G65101-12	F66101-12
		667-16	G65396-16	F62151-16	G65421-16	F66421-16
667-20		G65396-20	F62151-20	G65421-20	F66421-20	
667-24		G65396-24	F62151-24	G65421-24	F66421-24	
FORGED	AE240-3			G65104-3	F66104-3	
	666-4	G65117-4	F66631-4	G65104-4	F66104-4	
	666-5	G65117-5	F66631-5	G65104-5	F66104-5	
	666-6	G65117-6	F66631-6	G65104-6	F66104-6	
	666-8	G65117-8	F66631-8	G65104-8	F66104-8	
	BENT TUBE	666-10	G65116-10	F66693-10	G65103-10	F66103-10
		666-12	G65116-12	F66693-12	G65103-12	F66103-12
		667-16	G65397-16	F66746-16	G65422-16	F662422-16
667-20		G65397-20	F66746-20	G65422-20	F66422-20	
667-24	G65397-24	F66746-24	G65422-24	F66422-24		

4-Hole Flanged Elbows

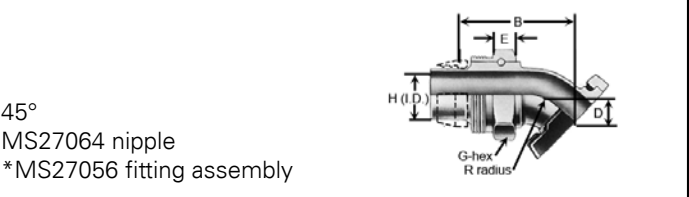
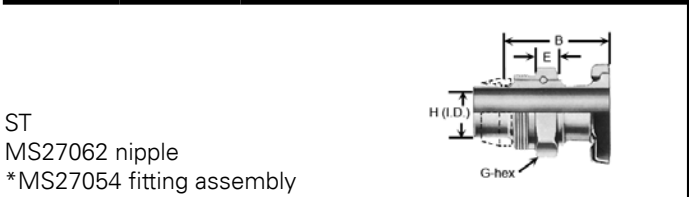

	ALUM Series			CRES Series	
	Hose	Nipple	Fitting Assy.	Nipple	Fitting Assy.
STRAIGHT TUBE	666-8	G61010-8	F2010-8	G61008-8	F62008-8
	666-10	G61010-10	F6210-10	G61008-10	F62008-10
	666-12	G61010-12	F6210-12	G61008-12	F62008-12
	667-16	G61009-16	F62009-16	G61007-16	F62007-16
	667-20	G61109-20	F62009-20	G61007-20	F62007-20
	667-24	†G61009-24	F62009-24	†G61007-24	F62007-24
BENT TUBE	666-8	G65119-8	F66722-8	G65121-8	F66121-8
	666-10	G65119-10	F66722-10	G65121-10	F66121-10
	666-12	G65119-12	F66722-12	G65121-12	F66121-12
	667-16	G65193-16	F66513-16	G65244-16	F66244-16
	667-20	G653193-20	F66513-20	G65244-20	F66244-20
	667-24	†G65193-24	F66513-24	†G65244-24	F66244-24
BENT TUBE	666-8	G65120-8	F66723-8	G65122-8	F66122-8
	666-10	G65120-10	F66723-10	G65122-10	F66122-10
	666-12	G65120-12	F66723-12	G65122-12	F66122-12
	667-16	G65194-16	F66512-16	G65245-16	F66245-16
	667-20	G65194-20	F66512-20	G65245-20	F66245-20
	667-24	†G65194-24	F66512-24	†G65245-24	F66245-24

† Nipple with removable flange - other sizes captive
* Add (size) to MS number. If material is to be CRES, add suffix "C" to size.

Refer to images on previous page.

	Dash Size	-----Weight (lbs.)-----				-----Fitting-----				
		CRES	ALUM	Max. A	Cut-Off B	C	Nominal D	E	F	
45° Flareless	FORGED	-3	.060/.027	.021/.009	1.70/43.18	1.23/31.24	.13/3.30	.432/10.972	.22/5.58	.44/11.17
		-4	.095/.043	.041/.018	1.92/48.76	1.29/32.76	.22/5.58	.424/10.76	.23/5.84	.44/11.17
		-5	.114/.051	.048/.021	1.99/50.54	1.32/33.52	.22/5.58	.448/11.37	.25/6.35	.56/14.22
		-6	.139/.063	.059/.026	2.11/53.59	1.43/36.32	.19/4.82	.526/13.36	.27/6.85	.56/14.22
		-8	.263/.119	.147/.066	2.73/69.34	1.95/49.53	.21/5.33	.622/15.79	.31/7.87	.62/15.74
	BENT TUBE	-10	.302/.136	.127/.057	2.62/66.54	1.77/44.95	.24/6.09	.725/18.41	.31/7.87	-
		-12	.482/.218	.184/.083	3.07/77.97	2.23/56.64	.31/7.87	.800/20.32	.36/9.14	-
		-16	.722/.327	.276/.125	3.21/81.53	2.33/59.18	.32/8.12	.854/21.69	.41/10.41	-
		-20	1.115/.505	.453/.205	3.72/94.48	2.61/66.29	.36/9.14	.962/24.43	.44/11.17	-
		-24	1.838/.833	.741/.336	4.12/104.64	3.03/76.96	.32/8.12	1.155/29.33	.50/12.70	-
90° Flareless	FORGED	-3	.065/.029	.027/.012	1.33/33.7	.86/21.84	.13/3.30	.741/18.82	.22/5.58	.44/11.17
		-4	.101/.045	.042/.019	1.54/39.11	.91/23.11	.22/5.58	.725/18.41	.23/5.84	.44/11.17
		-5	.126/.057	.053/.024	1.63/41.40	.97/24.63	.22/5.58	.808/20.52	.25/6.35	.56/14.22
		-6	.164/.074	.064/.029	1.71/43.43	1.03/26.16	.19/4.82	.915/23.24	.27/6.85	.56/14.22
		-8	.297/.134	.148/.067	2.09/53.08	1.31/33.27	.21/5.33	1.052/26.72	.31/7.87	.62/15.74
	BENT TUBE	-10	.311/.141	.133/.060	2.26/57.40	1.41/35.81	.24/6.09	1.392/35.35	.31/7.87	-
		-12	.507/.229	.208/.094	2.76/70.10	1.92/48.76	.31/7.87	1.626/41.30	.36/9.14	-
		-16	.749/.339	.291/.131	2.93/74.42	2.05/52.07	.32/8.12	1.776/45.11	.41/10.41	-
		-20	1.192/.540	.477/.216	3.45/87.63	2.34/59.43	.36/9.14	2.056/52.22	.44/11.17	-
		-24	1.887/.855	.760/.344	3.77/95.75	2.68/68.07	.32/8.12	2.438/61.92	.50/12.70	-

	Dash Size	-----Weight (lbs.)-----				-----Fitting-----			
		CRES	ALUM	Max. A	Cut-Off B	Nominal D	E	G	
Straight	STRAIGHT TUBE	-8	.267/.121	.168/.076	2.04/51.81	1.27/32.25	-	.31/7.87	.88/22.35
		-10	.331/.150	.197/.089	2.17/55.11	1.35/34.29	-	.31/7.87	1.00/25.40
		-12	.377/.171	.227/.102	2.36/59.94	1.55/39.37	-	.36/9.14	1.12/28.44
		-16	.666/.302	.352/.159	2.46/62.48	1.61/40.89	-	.41/10.41	1.50/38.10
		-20	1.099/.498	.573/.259	2.77/70.35	1.69/42.92	-	.44/11.17	1.81/45.97
		-24	1.212/.549	.814/.369	2.87/72.89	1.81/45.97	-	.50/12.70	2.12/53.84
45°	BENT TUBE	-8	.256/.116	.152/.068	2.05/52.06	1.25/31.75	.338/8.58	.31/7.87	.88/22.35
		-10	.317/.143	.177/.080	2.26/57.40	1.42/36.06	.375/9.52	.31/7.87	1.00/25.40
		-12	.428/.194	.245/.111	2.74/69.59	1.90/48.26	.468/11.88	.36/9.14	1.12/27.94
		-16	.652/.295	.362/.164	2.86/72.64	1.98/50.29	.505/12.82	.41/10.41	1.50/38.10
		-20	1.089/.493	.586/.265	3.32/84.32	2.22/56.38	.569/14.45	.44/11.17	1.81/45.97
		-24	1.533/.695	.810/.367	3.58/90.93	2.50/63.50	.624/15.84	.50/12.70	2.12/53.84
90°	BENT TUBE	-8	.262/.118	.162/.073	2.00/50.80	1.21/30.73	.772/19.60	.31/7.87	.88/22.35
		-10	.330/.149	.183/.083	2.26/57.40	1.41/35.81	.896/22.75	.31/7.87	1.00/25.40
		-12	.447/.202	.254/.115	2.76/70.10	1.92/48.76	1.156/29.36	.36/9.14	1.12/27.94
		-16	.679/.307	.397/.180	2.93/74.42	2.05/52.07	1.282/32.56	.41/10.41	1.50/38.10
		-20	1.151/.522	.586/.265	3.45/87.63	2.34/59.43	1.500/38.10	.44/11.17	1.81/45.97
		-24	1.606/.728	.875/.396	3.77/95.75	2.68/68.07	1.688/42.87	.50/12.70	2.12/53.84

Dimensions: inches/mm

Max "A" measured from seal surface to end of socket

“super gem” Swivel Nut Globeseal Flareless & 4 Hole Flanged Elbows Fittings in accordance with MIL-DTL-27272

Globeseal Flareless Elbows (Refer to images on page 16)

	Dash Size	MS 27077 Flange			Socket			Nut		
		G	Min H	R	U	Max V	W	Thread T	Hex Y	
45° Flareless	FORGED	-3	.44/11.176	.090/2.286		.62/15.748	.52/13.208	.44/11.176	.3750-24	.50/12.700
		-4	.56/14.22	.160/4.06		.81/20.57	.66/16.76	.56/14.22	4375-20	.56/14.22
		-5	.62/15.74	.220/5.58		.83/21.08	.73/18.54	.62/15.748	5000-20	.62/15.74
		-6	.69/17.52	.261/6.62		.85/21.59	.81/20.57	.69/17.52	.5625-18	.69/17.52
		-8	.88/22.35	.345/8.76		.98/24.89	1.02/25.90	.88/22.35	.7500-16	.88/22.35
	BENT TUBE	-10	1.00/25.40	.440/11.17	.62/15.74	1.08/27.43	1.17/29.71	1.00/25.04	.8750-14	1.00/25.40
		-12	1.12/28.44	.560/14.22	.84/21.33	1.15/29.21	1.31/33.27	1.12/28.44	1.0625-12	1.25/31.75
		-16	1.50/38.10	.828/21.03	.97/24.63	1.26/32.00	1.74/44.19	1.50/38.10	1.3125-12	1.50/38.10
		-20	1.81/45.97	1.058/26.87	1.19/30.22	1.51/38.35	2.18/55.37	1.88/47.75	1.6250-12	1.81/45.97
		-24	2.12/53.84	1.253/31.82	1.39/35.30	1.59/40.38	2.46/62.48	2.12/53.84	1.8750-12	2.12/53.84
90° Flareless	FORGED	-3	.44/11.17	.090/2.28	-	.62/15.74	.52/13.20	.44/11.17	.3750-24	.50/12.70
		-4	.56/14.22	.160/4.06	-	.81/20.57	.66/16.76	.56/14.22	4375-20	.56/14.22
		-5	.62/15.74	.220/5.58	-	.83/21.08	.73/18.54	.62/15.74	5000-20	.62/15.74
		-6	.69/17.52	.261/6.62	-	.85/21.59	.81/20.57	.69/17.52	.5625-18	.69/17.52
		-8	.88/22.35	.345/8.76	-	.98/24.89	1.02/25.90	.88/22.35	.7500-16	.88/22.35
	BENT TUBE	-10	1.00/25.40	.440/11.17	.62/15.74	1.08/27.43	1.17/29.71	1.00/25.40	.8750-14	1.00/25.40
		-12	1.12/28.44	.560/14.22	.84/21.33	1.15/29.21	1.31/33.27	1.12/28.44	1.0625-12	1.25/31.75
		-16	1.50/38.10	.828/21.03	.97/24.63	1.26/32.00	1.74/44.19	1.50/38.10	1.3125-12	1.50/38.10
		-20	1.81/45.97	1.058/26.87	1.19/30.22	1.51/38.35	2.18/55.37	1.88/47.75	1.6250-12	1.81/45.97
		-24	2.12/53.84	1.253/31.82	1.38/35.05	1.58/40.13	2.46/62.48	2.12/53.84	1.8750-12	2.12/53.84

4-Hole Flanged Elbows

	Dash Size	MS 27077 Flange			Socket		
		Min H	R	U	Max V	W	
Straight	STRAIGHT TUBE	-8	.345/8.76	.50/12.70	.98/24.89	1.02/25.90	.88/22.35
		-10	.440/11.17	.62/15.74	1.08/27.43	1.17/29.71	1.00/25.40
		-12	.560/14.22	.84/21.33	1.15/29.21	1.31/33.27	1.12/28.44
		-16	.828/21.03	.97/24.63	1.26/32.00	1.74/44.19	1.50/38.10
		-20	1.058/26.87	1.19/30.22	1.51/38.35	2.18/55.37	1.88/47.75
		-24	1.282/32.56	1.38/35.05	1.58/40.13	2.46/62.48	2.12/53.84
45°	BENT TUBE	-8	.345/8.76	.50/12.70	.98/24.89	1.02/25.90	.88/22.35
		-10	.440/11.17	.62/15.74	1.08/27.43	1.17/29.71	1.00/25.40
		-12	.560/14.22	.84/21.33	1.15/29.21	1.31/33.27	1.12/28.44
		-16	.828/21.03	.97/24.63	1.26/32.00	1.74/44.19	1.50/38.10
		-20	1.058/26.87	1.19/30.22	1.51/38.35	2.18/55.37	1.88/47.75
		-24	1.253/31.82	1.38/35.05	1.58/40.13	2.46/62.48	2.12/53.84
90°	BENT TUBE	-8	.345/8.76	.50/12.70	.98/24.89	1.02/25.90	.88/22.35
		-10	.440/11.17	.62/15.74	1.08/27.43	1.17/29.71	1.00/25.40
		-12	.560/14.22	.84/21.33	1.15/29.21	1.31/33.27	1.12/28.44
		-16	.828/21.03	.97/24.63	1.26/32.00	1.74/44.19	1.50/38.10
		-20	1.058/26.87	1.19/30.22	1.51/38.35	2.18/55.37	1.88/47.75
		-24	1.253/31.82	1.38/35.05	1.58/40.13	2.46/62.48	2.12/53.84

Dimensions: inches/mm

R = Radius of Elbow measured to center line

"super gem" Hose Assemblies/Swivel Flared to Swivel Flared

All hose assemblies shown on this page conform to MS8000. MS style code indicates configuration and material. In accordance with MIL-DTL-25579.

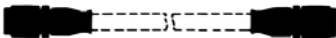
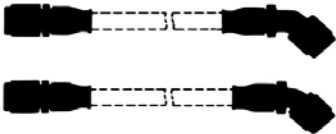
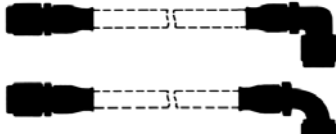
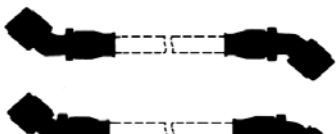
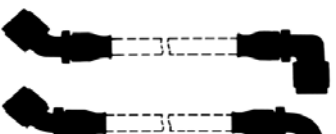
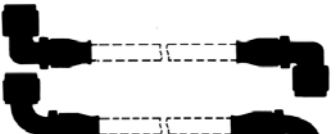
A	B	Dash Size*	Material	Assembly Base No.	MS Style Code	Nipple A Part No.	Nipple B Part No.
		-4 thru -12	ALUM	T666002	G	G65008	G65008
			CRES	M666000	A	G65000	G65000
		-16 thru -24	ALUM	T667004	G	G65058	G65058
			CRES	M667000	A	G65057	G65057
	FORGED	-4 thru -8	ALUM	T666306	H	G65008	G6529
			CRES	M666300	B	G65000	G6533
	BENT TUBE	-10 and -12	ALUM	T666111	H	G65008	G6530
			CRES	M666100	B	G65000	G6534
		-16 thru -24	ALUM	T667119	H	G65058	G6563
			CRES	M667118	B	G65057	G6562
	FORGED	-4 thru -8	ALUM	T666305	J	G65008	G6531
			CRES	M666301	C	G65000	G6505
	BENT TUBE	-10 and -12	ALUM	T666110	J	G65008	G6532
			CRES	M666101	C	G65000	G6506
		-16 thru -24	ALUM	T667121	J	G65058	G6561
			CRES	M667108	C	G65057	G6560
	FORGED	-4 thru -8	ALUM	T666315	K	G6529	G6529
			CRES	M666302	D	G6533	G6533
	BENT TUBE	-10 and -12	ALUM	T666120	K	G6530	G6530
			CRES	M666102	D	G6534	G6534
		-16 thru -24	ALUM	T667124	K	G6563	G6563
			CRES	M667123	D	G6562	G6562
	FORGED	-4 thru -8	ALUM	T666316	M	G6529	G6531
			CRES	M666303	E	G6533	G6505
	BENT TUBE	-10 and -12	ALUM	T666121	M	G6530	G6532
			CRES	M666103	E	G6534	G6506
		-16 thru -24	ALUM	T667127	M	G6563	G6561
			CRES	M667126	E	G6562	G6560
	FORGED	-4 thru -8	ALUM	T666310	N	G6531	G6531
			CRES	M666304	F	G6505	G6505
	TUBE	-10 and -12	ALUM	T666114	N	G6532	G6532
			CRES	M666104	F	G6506	G6506
		-16 thru -24	ALUM	T667130	N	G6561	G6561
			CRES	M667129	F	G6560	G6560

* -3 size assemblies available. Contact Eaton for information

"super gem" Swivel Flareless to Swivel Flareless

All hose assemblies shown on this page conform to MS8001. MS style code indicates configuration and material. In accordance with MIL-DTL-25579.

A	B	Dash Size*	Material	Assembly Base No.	MS Style Code	Nipple A Part No.	Nipple B Part No.
		-4 thru -12	ALUM	T666035	G	G65016	G65016
			CRES	M666049	A	G65018	G65018
		-16 thru -24	ALUM	T667012	G	G67022	G67022
			CRES	M667014	A	G67023	G67023
		-4 thru -8	ALUM	T666320	H	G65016	G65114
			CRES	M666384	B	G65018	G65113
		-10 and -12	ALUM	T666125	H	G65016	G65102
			CRES	M666261	B	G65018	G65101
		16 thru -24	ALUM	T667142	H	G67022	G65396
			CRES	M667171	B	G67023	G65421
		-4 thru -8	ALUM	T666319	J	G65016	G65117
			CRES	M666371	C	G65018	G65104
		-10 and -12	ALUM	T666124	J	G65016	G65116
			CRES	M666276	C	G65018	G65103
		16 thru -24	ALUM	T667143	J	G67022	G65397
			CRES	M667172	C	G67023	G65422
		-4 thru -8	ALUM	T666372	K	G65114	G65114
			CRES	M666385	D	G65113	G65113
		-10 and -12	ALUM	T666272	K	G65102	G65102
			CRES	M666277	D	G65101	G65101
		16 thru -24	ALUM	T667168	K	G65396	G65396
			CRES	M667173	D	G65421	G65421
		-4 thru -8	ALUM	T666344	M	G65114	G65117
			CRES	M666386	E	G65113	G65104
		-10 and -12	ALUM	T666273	M	G65102	G65116
			CRES	M666278	E	G65101	G65103
		16 thru -24	ALUM	T667169	M	G65396	G65397
			CRES	M667174	E	G65421	G65422
		-4 thru -8	ALUM	T666314	N	G65117	G65117
			CRES	M666387	F	G65104	G65104
		-10 and -12	ALUM	T666148	N	G65116	G65116
			CRES	M666279	F	G65103	G65103
		16 thru -24	ALUM	T667170	N	G65397	G65397
			CRES	M667175	F	G65422	G65422

* -3 size assemblies available. Contact Eaton for information.

"super gem" Hose Assemblies/Swivel Flared to 4-Hole Flange

All hose assemblies shown on this page conform to MS8002. MS style code indicates configuration and material. In accordance with MIL-DTL-25579.

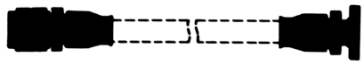
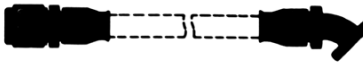
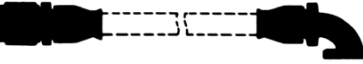
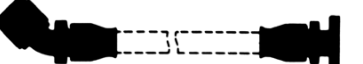
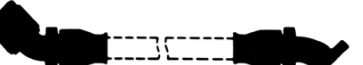
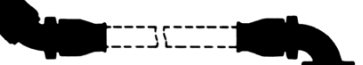
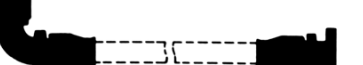
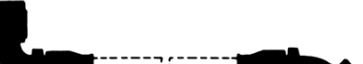
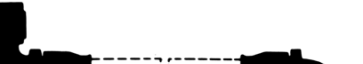
A	B	Dash Size*	Material	Assembly Base No.	MS Style Code	Nipple A Part No.	Nipple B Part No.
		-10 and -12	ALUM	T666042	K	G65008	G61010
			CRES	M666043	A	G65000	G61008
		-16 thru -24	ALUM	T667003	K	G65058	G61009
			CRES	M667029	A	G65057	G61007
	BENT TUBE	-10 and -12	ALUM	T666138	M	G65008	G65119
			CRES	M666139	B	G65000	G65121
		-16 thru -24	ALUM	T667111	M	G65058	G65193
			CRES	M667189	B	G65057	G65244
	BENT TUBE	-10 and -12	ALUM	T666140	N	G65008	G65120
			CRES	M666141	C	G65000	G65122
		-16 thru -24	ALUM	T667115	N	G65058	G65194
			CRES	M667190	C	G65057	G65245
	BENT TUBE	-10 and -12	ALUM	T666170	T	G6530	G61010
			CRES	M666265	G	G6534	G61008
		16 thru -24	ALUM	T667109	T	G6563	G61009
			CRES	M667191	G	G6562	G61007
	BENT TUBE	-10 and -12	ALUM	T666142	P	G6530	G65119
			CRES	M666143	D	G6534	G65121
		16 thru -24	ALUM	T667106	P	G6563	G65193
			CRES	M667192	D	G6562	G65244
	BENT TUBE	-10 and -12	ALUM	T666144	R	G6530	G65120
			CRES	M666145	E	G6534	G65122
		16 thru -24	ALUM	T667116	R	G6563	G65194
			CRES	M667193	E	G6562	G65245
	BENT TUBE	-10 and -12	ALUM	T666158	U	G6532	G61010
			CRES	M666159	H	G6506	G61008
		16 thru -24	ALUM	T667110	U	G6561	G61099
			CRES	M667194	H	G6560	G61007
	BENT TUBE	-10 and -12	ALUM	T666160	V	G6532	G65119
			CRES	M666161	J	G6506	G65121
		16 thru -24	ALUM	T667112	V	G6561	G65193
			CRES	M667195	J	G6560	G65244
	BENT TUBE	-10 and -12	ALUM	T666146	S	G6532	G65120
			CRES	M666147	F	G6506	G65122
		16 thru -24	ALUM	T667101	S	G6561	G65194
			CRES	M667196	F	G6560	G65245

* -8 size assemblies available. Contact Eaton for information.

4-Hole Flange to 4-Hole Flange

All hose assemblies shown on this page conform to MS8004. MS style code indicates configuration and material. In accordance with MIL-DTL-25579.

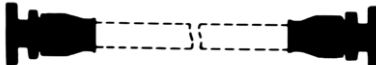
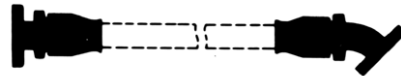
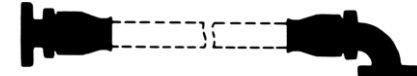
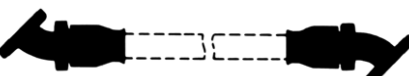
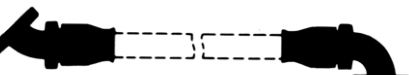
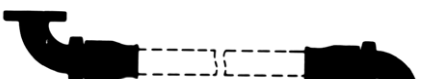
A	B	Dash Size	Material	Assembly Base No.	MS Style Code	Nipple A Part No.	Nipple B Part No.
		-10 and -12	ALUM	M666040	G	G61010	G61010
			CRES	M666041	A	G61008	G61008
		-16 thru -24	ALUM	T667002	G	G61009	G61009
			CRES	M667030	A	G61007	G61007
	BENT TUBE	-10 and -12	ALUM	T666128	H	G61010	G65119
			CRES	M666129	B	G61008	G65121
		-16 thru -24	ALUM	T667104	H	G61009	G65193
			CRES	M667197	B	G61007	G65244
	BENT TUBE	-10 and -12	ALUM	T666130	J	G61010	G65120
			CRES	M666131	C	G61008	G65122
		-16 thru -24	ALUM	T667105	J	G61009	G65194
			CRES	M667198	C	G61007	G65245
	BENT TUBE	-10 and -12	ALUM	T666132	K	G65119	G65119
			CRES	M666133	D	G65121	G65121
		16 thru -24	ALUM	T667113	K	G65193	G65193
			CRES	M667199	D	G65244	G65244
	BENT TUBE	-10 and -12	ALUM	T666164	M	G65119	G65120
			CRES	M666135	E	G65121	G65122
		16 thru -24	ALUM	T667114	M	G65193	G65194
			CRES	M667200	E	G65244	G65245
	BENT TUBE	-10 and -12	ALUM	T666136	N	G65120	G65120
			CRES	M666137	F	G65122	G65122
		16 thru -24	ALUM	T667117	N	G65194	G65194
			CRES	M667201	F	G65245	G65245

* -8 size assemblies available. Contact Eaton for information.

How To Assemble Medium Pressure PTFE Hose and “super gem” Reusable Fittings

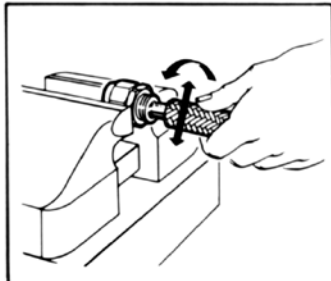

Step 1.

Wrap hose with tape at cut-off point and cut squarely to length through taped area using a sharp cut-off wheel or a fine-tooth hacksaw. Remove tape and trim any loose wires flush with tube stock. Any burrs on the bore of the tube stock should be removed with a knife. Clean the hose bore. Sometimes wire braid will tend to “neck down” on one end and “flare out” on the opposite end. This is characteristic of wire braid hose and can be used to an advantage in the assembly of the “super gem” fittings. Slip two sockets skirt-to-skirt over the “necked down” end of the hose. Mount nipple hex in a vise. Work the hose bore over the nipple in a circular motion to size the tube and aid in separating the braid prior to fitting the sleeve. Remove hose from nipple.

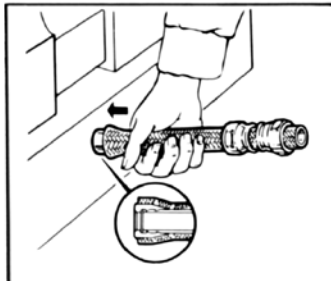

Step 2.

Carefully insert the sleeve over the end of the inner tube and under the wire braid by hand. Complete positioning of the sleeve by pushing the sleeve end against a flat surface until tube bottoms are against shoulder in sleeve I.D. Visually inspect to see that tube stock butts against the inside shoulder of the sleeve and that no wires are trapped under sleeve.

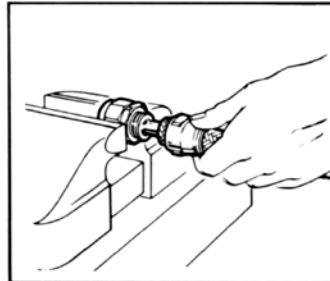

Step 3.

Hold the nipple with hex in vise. Push hose over nipple with twisting motion until seated against nipple chamfer. Push socket forward, and hand start threading of socket to nipple.

Note: When assembling new fittings no lubrication is needed as component parts are dry film lubricated at the time of manufacture. After reuse of the fitting, if undue wearing of the dryfilm or bare metal is observed, the thread area should be lubricated with Molykote G-n Paste.

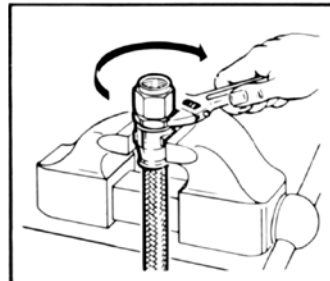

Step 4.

Wrench tighten nipple hex until clearance with socket hex is 1/32” [0.079 mm] or less (may vary from 0.023 [0.584 mm] to 0.046 inch [1.168]). Tighten further to align corners of nipple and socket hexes.

Step 5.

Proof test all completed. Assemblies to 3000 PSIG

How To Assemble Medium Pressure PTFE Hose and “super gem” Reusable Fittings

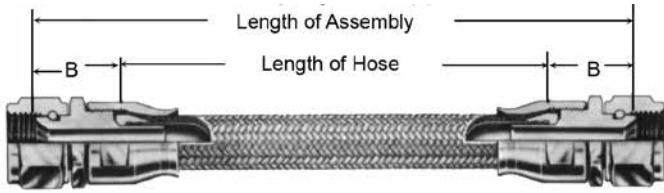

Determine hose cut-off length by subtracting fitting cut-off factor (B+B) from hose assembly length or by calculating the length from the information shown on the hose assembly drawing. The cut-off length may also be determined by measuring the used length of hose being replaced.

How to Complete Assembly Part Number

Measure assembly length from end fitting sealing surface to end fitting sealing surface (see page 4, “Assembly length” call-out on hose assembly picture). Assembly length is always expressed in four digits (see example).

Hose size is expressed as a dash number, which designates the tube OD in 1/16’s of an inch. This number is added immediately following the basic style number and is normally separated from it with a dash. However, on assemblies with elbow fittings on each end, hose size is expressed with an alphabetic code; a similar code letter may be used to indicate jump size. When position angle and letter code are used, dashes are omitted between basic style number and hose size; also between hose size and lengths.

Position Angle

On assemblies with an elbow fitting on each end, measure the position angle as shown above and prefix the angle to the basic style number. In all cases, the angle should be expressed in 3 digits. For example: 35° should be written as 035. If the angle desired is 0°, specify 000.

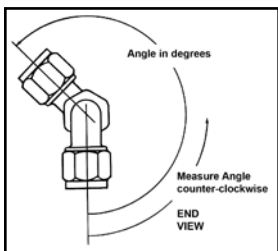

Hose Size (dash size)

Dash Size	Letter Code
-4	E
-5	F
-6	G
-8	H
-10	J
-12	K
-16	M
-20	N
-24	P

Basic Assembly Numbers

The basic part numbers shown here represent standard configurations with materials, markings, and cleaning requirements conforming to MIL-DTL-25579. If your requirements differ from these standards, the hose assemblies you order will be assigned new numbers by Eaton.

These part numbers are generated as follows:

EXAMPLE:

Straight to Straight Assemblies

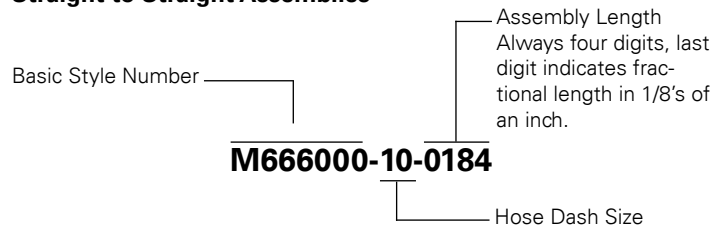

Double Elbow Assemblies

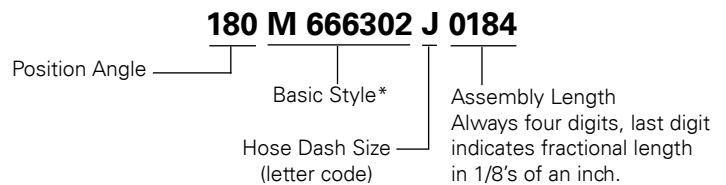

Part Numbers Assigned Prior to January 2, 1964

- No AE Prefix
- The following chart shows the letter code previously used to indicate sizes in the same part numbers

Dash Size	2	3	4	5	6	8	10	12	16	20	24	32	40	48	64	80	96	*
Letter Code	A	E	F	G	H	J	K	L	M	N	P	R	T	U	V	W	Y	Z

* Special Part Numbers

Aeroquip PTFE Hose Assemblies with Integral Polyester Chafe Guard MIL-DTL-25579 1500 psi Hydraulic Service

**AE566 Medium Pressure PTFE Hose with “super gem” Fitting
Per MIL-DTL-27272 (for use with MIL-DTL-27267 Hose)**



AE566 Medium Pressure PTFE Hose with Compression Crimp

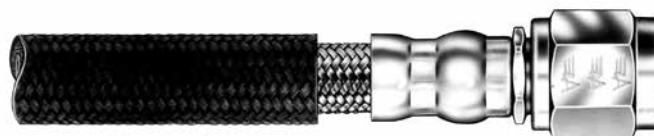

Aeroquip PTFE Hose Assemblies with Integral Polyester Chafe Guard

Eaton's Aeroquip braided polyester chafe resistant hose is manufactured by braiding polyester yarn onto 666 hose.

Advantages of Aeroquip polyester chafe-resistant hose:

- Superior chafe-resistance (see comparison chart on page 16)
- Compatible with Aerospace associated fluids (see compatibility chart on page 24)
- Adds minimal weight
- Minimal increase in O.D.
- Flexibility is not impaired
- Temperature range – 65°F to +300°F (-54°C to +149°C)
- Assemblies can be fabricated from bulk hose and fittings. See Eaton Service Bulletin ASB116R-1 for AE546 hose, ASB73R-1 for AE566 hose and ASB120A for thermal stripping tool.

Dash Size	O.D. Tube Size	Hose I.D. (Min.)	Hose O.D. (Max.)	Operating Pressure (psi/kPa)	Proof Pressure (psi/kPa)	Room Temp Min. Burst Pressure (psi/kPa)	Min. Bend Radius	Weight Per Foot (lbs./kg)
AE566-4	1/4	.173/4.39	.448/11.37	1500/10342	3000/20684	12000	2.00/50.8	.096/.043
AE566-5	5/16	.235/5.96	.501/12.72	1500/10342	3000/20684	10000	2.00/50.8	.121/.054
AE566-6	3/8	.298/7.56	.559/14.19	1500/10342	3000/20684	9000	4.00/101.6	.135/.061
AE566-8	1/2	.391/9.93	.665/16.89	1500/10342	3000/20684	8000	4.62/117.3	.181/.082
AE566-10	5/8	.485/12.31	.772/19.60	1500/10342	3000/20684	7000	5.50/139.7	.214/.097
AE566-12	3/4	.615/15.62	.887/22.52	1000/6894	2000/13789	5000	6.50/165.1	.274/.124
AE566-16	1	.851/21.61	1.210/30.73	1250/8618	2500/17236	5000	7.38/187.4	.516/.234
AE566-20	1 1/4	1.101/27.96	1.460/37.08	1000/6894	2000/13789	4000	11.00/279.4	.646/.293
AE566-24	1 1/2	1.344/34.13	1.782/45.26	1000/6894	2000/13789	4000	14.00/355.6	.860/.390

All Dimensions in inches/mm.

NOTE: For additional information on 666/667 hose, see page 4.

Aeroquip PTFE Hose Assemblies with Integral Polyester Chafe Guard Fittings/Hose Assemblies

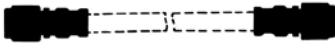
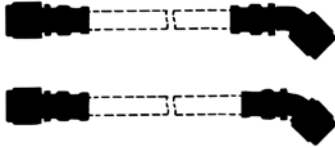
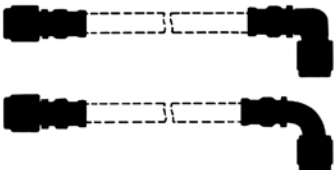
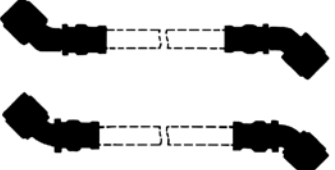
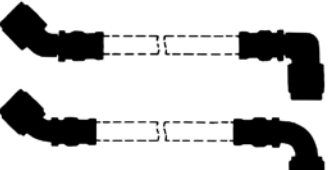
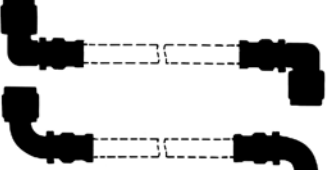
Configuration	Fittings (Per MIL-DTL-27272)	AE566 Hose with "super gem" fittings (per MIL-DTL-25579)	AE566 Hose with Compression Crimp Fittings (per MIL-DTL-27267 & MIL-DTL-25579)
 Straight to Straight	FLARED 37° CRES	AE6665012	AE3663231
	FLARED 37° ALUMINUM	AE6665015	AE3663884
	FLARELESS CRES (NAS 1760)†	AE6665018	AE3663234
	FLARELESS ALUMINUM (NAS 1760)†	AE6665021	
 Straight to 45°	FLARED 37° CRES	AE6665013	AE36663232
	FLARED 37° ALUMINUM	AE6665016	AE3664072
	FLARELESS CRES (NAS 1760)†	AE6665019	AE3663235
	FLARELESS ALUMINUM (NAS 1760)†	AE6665022	
 Straight to 90°	FLARED 37° CRES	AE6665014	AE3663233
	FLARED 37° ALUMINUM	AE6665017	AE3664073
	FLARELESS CRES (NAS 1760)†	AE6665020	AE3663236
	FLARELESS ALUMINUM (NAS 1760)†	AE6665023	
 45° to 45°	FLARED 37° CRES	AE6239	AE6202
	FLARED 37° ALUMINUM	AE6242	AE6995
	FLARELESS CRES (NAS 1760)†	AE6245	AE6205
	FLARELESS ALUMINUM (NAS 1760)†	AE6248	
 45° to 90°	FLARED 37° CRES	AE6240	AE6203
	FLARED 37° ALUMINUM	AE6243	AE6996
	FLARELESS CRES (NAS 1760)†	AE6246	AE6206
	FLARELESS ALUMINUM (NAS 1760)†	AE6249	
 90° to 90°	FLARED 37° CRES	AE6241	AE6204
	FLARED 37° ALUMINUM	AE6244	AE6997
	FLARELESS CRES (NAS 1760)†	AE6247	AE6207
	FLARELESS ALUMINUM (NAS 1760)†	AE6250	

† CRES and Aluminum fittings for AE566 hose with "super gem" reusable fittings do not conform to NAS 1760 standards.

Aeroquip PTFE Hose Assemblies with Integral Polyester Chafe Guard Abrasion Comparison/Weight Comparison/Compatibility

Abrasion Comparison

Aeroquip PTFE hose with polyester chafe guard has been tested for abrasion resistance and compared with synthetic rubber sleeves and extruded silicone sleeves with the results on the graph below.

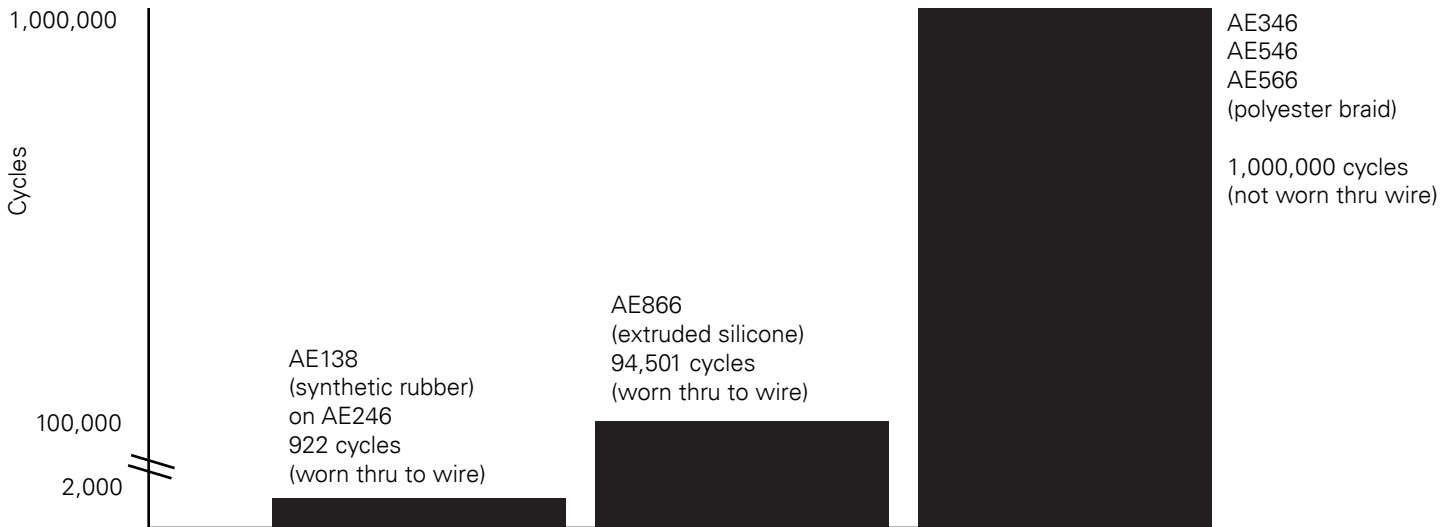

Weight Comparison

The following figures show the weight comparison between Aeroquip PTFE hose with polyester chafe guard and other commonly used sleeving materials (based on -8 six medium pressure hose):

Material	Weight Per Foot (Includes Hose) Lbs./kg
Braided Polyester	.175/.079
Neoprene Rubber	.186/.084
Extrude Silicone	.215/.097
Polyolifin	.167/.075
PTFE	.196/.088
Spiral Nylon	.153/.069

Compatibility

Eaton's Aeroquip PTFE hose with polyester chafe guard has been tested and shown to be compatible with the following fluids:

- LD4
- Highjet Chevron
- Skydrol 500B4
- JP-4 (MIL-T-5624)
- AvGas Grade 100/130 (MIL-C-5572)
- MIL-L-7808 Lube Oil
- Varsol (Cleaning Solvent)

How To Order — Aeroquip PTFE Hose Assemblies with Integral Polyester Chafe Guard

To properly specify the correct hose assembly, use the simple numbering system shown adjacent. Straight and single elbow assemblies are identified by the number beginning with either AE246, AE366 or AE666, and double elbow assemblies are identified by a number beginning AE4XXX or AE6XXX. Any assembly can be ordered using these numbers.

Assembly length in inches always four digits, last digit indicates fractional length in 1/8 inch increments

Number code for chafe guard and fitting configuration

Base Numbers for all straight and single elbow assemblies

AE4000 and AE6000 series applies to double elbow assemblies

Number code for chafe guards and fitting configurations

Assembly length in inches always four digits, last digit indicates fractional length in 1/8 inch increments

Elbow position angle expressed in three digits

AE666 0000 E 0184

AE 6000 E 0184-225

Size Code

Hose Dash Size	-4	-6	-8	-10	-12	-16	-20	-24
Letter Code	E	G	H	J	K	M	N	P

Aeroquip PTFE Hose Assemblies with Integral Silicone Firesleeve Performance Data — MIL-DTL-25579 and MIL-DTL-27267 1500 psi Hydraulic Service

AE466 Medium Pressure PTFE Hose with Compression Crimp Fitting



**AE466 Medium Pressure PTFE Hose with “super gem” Fitting
Per MIL-DTL-27272 (for use with MIL-DTL-27267 Hose)**



Aeroquip PTFE Hose Assemblies with Integral Silicone Firesleeve

Eaton’s Aeroquip integral silicone firesleeves on PTFE hose assemblies is a combination that meets the fire test requirements of TSO-C53A Type D and TSO-C75 Type III A and III B.

Available on both medium and high pressure Aeroquip PTFE hose assemblies, the silicone firesleeve is applied directly onto the metal braid and fittings to form a smooth, tight bond.

Advantages of Integral Silicone Firesleeve

- Silicone sleeve is asbestos free
- Adheres directly to hose
- Smaller envelope for neater appearance
- Hose flexibility is not impaired
- Non-age sensitive for extra-long shelf life
- Lightweight
- Eliminates the use of band clamps
- Eliminates fluid “wicking”
- Manufactured in long lengths
- Temperature range, -65°F to +450°F (-54°C to +232°C). Matches temperature range of PTFE hose.
- Excellent chafe resistance

The part number chart below shows the basic hose style and appropriate specifications as well as identification information.

Dash Size	O.D. Tube Size	Hose I.D. (Min.)	Hose O.D. (Max.)	Operating Pressure (psi/kPa)	Proof Pressure (psi/kPa)	Room Temp Min. Burst Pressure (psi/kPa)	Min. Bend Radius	Weight Per Foot (lbs./kg)
AE466-4	1/4	.173/4.39	.640/16.25	1500/10342	3000/20684	12000/82737	2.00/50.8	.220/.099
AE466-5	5/16	.235/5.96	.702/17.83	1500/10342	3000/20684	10000/68947	2.00/50.8	.270/.122
AE466-6	3/8	.298/7.56	.765/19.43	1500/10342	3000/20684	9000/62052	4.00/101.6	.292/.132
AE466-8	1/2	.391/9.93	.890/22.60	1500/10342	3000/20684	8000/55158	4.62/117.3	.385/.174
AE466-10	5/8	.485/12.31	.979/24.86	1500/10342	3000/20684	7000/48263	5.50/139.7	.451/.204
AE466-12	3/4	.615/15.62	1.104/28.04	1000/6894	2000/20684	5000/34473	6.50/165.1	.534/.242
AE466-16	1	.851/21.61	1.424/36.16	1250/8618	2500/17236	5000/34473	7.38/187.4	.924/.419
AE466-20	1 1/4	1.101/27.96	1.679/42.64	1000/6894	2000/17236	4000/27579	11.00/279.4	1.161/.526
AE466-24	1 1/2	1.344/34.13	1.987/50.46	1000/6894	2000/17236	4000/27579	14.00/355.6	1.485/.673

Dimensions: inches/mm

NOTE: For additional information on 666/667 hose, see pages 3 and 4.

Aeroquip PTFE Hose Assemblies with Integral Silicone Fittings/Hose Assemblies

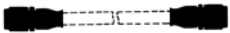
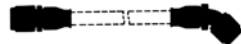
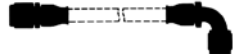
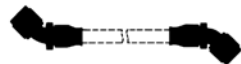
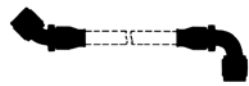
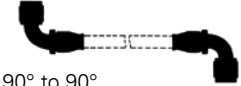
Configuration	Hose Size: -4 thru -24	Type	AE466 Hose with CRES "super gem" fittings (Per MIL-H-27267 & MIL-DTL-25579)	AE466 Hose with CRES compression Crimp Fittings (Per MIL-DTL-27267 & MIL-DTL-25579)	AE866 Hose with Compression Crimp CRES Fittings
 Straight to Straight	-4 thru -24	FLARED	AE6665000	AE3663161	AE3663962
		FLARELESS*	AE6665006	AE3663167	AE3664019
 Straight to 45°	-4 thru -24	FLARED	AE6665001	AE3663162	AE3664017
		FLARELESS*	AE6665007	AE3663168	AE3664020
 Straight to 90°	-4 thru -24	FLARED	AE6665002	AE3663163	AE3663948
		FLARELESS*	AE6665008	AE3663169	AE3664021
 45° to 45°	-4 thru -24	FLARED	AE6211	AE6208	AE6749
		FLARELESS*	AE6217	AE6190	AE8045
 45° to 90°	-4 thru -24	FLARED	AE6212	AE6209	AE6750
		FLARELESS*	AE6218	AE6191	AE8046
 90° to 90°	-4 thru -24	FLARED	AE6213	AE6210	AE6751
		FLARELESS*	AE6219	AE6192	AE8047

* CRES and Aluminum fittings for AE466 hose with "super gem" reusable fittings do not conform to NAS 1760 standards.
ALUMINUM FITTINGS MAY BE AVAILABLE UPON REQUEST. PLEASE CONTACT EATON.

How To Order — Aeroquip PTFE Hose Assemblies with Integral Silicone Firesleeve

Assemblies can be fabricated from bulk hose and fittings.

Hose Compatibility

Eaton Aeroquip PTFE hose with integral silicone firesleeve has been tested and shown to be compatible with the following fluids:

- Fire Resistant Hydraulic Fluids
- JP-4 (MIL-T-5624)
- AvGas Grade 100/130 (MIL-C-5572)
- MIL-L-7808 Lube Oil
- Varsol (cleaning solvent)

How To Order

To properly specify the correct hose assembly, use the simple numbering system shown adjacent. Straight and single elbow assemblies are identified by the number beginning with either AE366 or AE666 and double elbow assemblies are identified by a number beginning AE4XXX or AE6XXX. Any assembly can be ordered using these numbers.

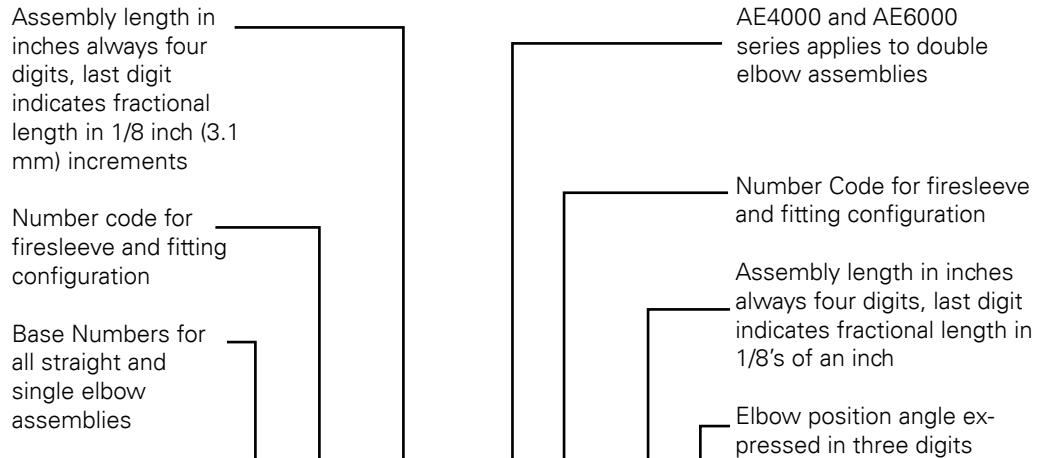

AE666 5000 E 0184 AE6213 E 0184-225

Size Code

Hose Dash Size	-4	-6	-8	-10	-12	-16	-20	-24
Letter Code	E	G	H	J	K	M	N	P

Eaton
Aerospace Group
Fluid & Electrical Distribution Division
300 South East Avenue
Jackson, Michigan 49203-1972
Phone: (517) 787 8121
Fax: (517) 789 2947

Eaton
Aerospace Group
9650 Jeronimo Road
Irvine, California 92618
Phone: (949) 452-9500
Fax: (949) 452-9555
www.eaton.com/aerospace

Copyright © 2020 Eaton
All Rights Reserved
Teflon™ is a trademark of The Chemours
Company FC, LLC
Molykotei G-nPaste is a registered trademark
of the Dow Corporation.
Copying or Editing is Forbidden
Form No. TF100-25E
(Supersedes: AEB170, AAB4, AEB221A and
AEB 229A)
December 2020